

Institute OF THE Flying Arts

PRESENT

DG-600 Jetpower



Historical

The **DG-600** is a high performance glider, manufactured by Glaser-Dirks Flugzeugbau as a successor to the DG-200 and DG-400 series of gliders in 1987.

In 1991 the DG-600M with an Rotax engine and self launching capability was released. The fuselage was based on the design of the DG-400 but with a more slender tailboom, canopy and the instrument panel stood basically the same as on other DG gliders.

The control surfaces now incorporated flaperons which serve as both flaps and aileron and the wing had a newly designed thinner airfoil and higher aspect ratio than previous types of DG gliders. Initial problems with critical slow speed behaviour could be improved by the use of winglets, clip-on wings or both, but only 112 aircraft were produced until the moulds were destroyed in a factory fire and the DG-800 became its successor.

About the model

This model of a DG-600M is packed full of features that will enlighten the heart of any RC-glider fan and is intended for the more experienced pilot or advanced beginner.

It comes with a retractable gear, flaperons and a 50mm retractable EDF unit, that not only gives it self starting capabilities and a good climb rate, but also offers loads of fun in powered acrobatics.

Equipped with a 2600mAh 4S battery you will get about 6 min of engine power, but that usually doesn't mean your flight time! In calm conditions, it's not difficult to make 20 minutes or more just gliding, but in good ones you can easily get to the thermals within your reach and then attempt (and possibly succeed) to fly them out. This bird likes to stay up!

The hull prints about 70% of standard and 30% of light-weight PLA and a little FlexiLight for the tires.

Gear and EDF mechanics are 3D printed as well and you 'll have to get not much more than some carbon rods, some (okay... many) tiny din-screws, steel wires and some brass tubes, next to your radio equipment to complete the build.

Finally, for the scale enthusiasts that want to show some cockpit, the set contains data and guide to produce your own clear canopy (access to a resin printer is recommended) or you may want to order one in the [IFA Supply Store](#), where you'll find the screws, drives, complete sets and more.

Parameters

Scale ca.:	1 : 6
Wingspan:	2600mm
Length:	1180 mm
Print weight ca.:	1300 g
Weight fully equipped ca.:	1800 g
Wing profile:	HQ 25/12
Speed:	advanced

Requirements

All parts were printed on Prusa Mk3 and MK4
Minimum print volume : 200x200x180mm.
Recommended nozzle : 0.4 mm
Slicing software : Prusa slic3r 2.8.1

Print settings

In general I recommend using the 3mf files provided. They contain the correct print settings for the material as well as additional slicer settings to achieve the part properties needed. If you otherwise decide to use a different slicing software, please refer to the part-settings made in the 3mf files. In case of symmetric parts, like most of the wing sections, the .stl file ends on _L&R, which means you'll have to mirror it to generate the opposite part.

Hull parts: The rear section of the fuselage (parts _5 to _8) and the tail unit are to be printed in light-weight PLA like [PolyLight](#) from 3DLabprint or similar. Please print all Lightweight part separately. (Click on the "eye"-symbol next to the part name in Prusa-slicer to activate/deactivate printing of the part.)

Wings and fuselage front parts need to be more rigid and are printed with [PolyAir](#) or any standard or effect PLA you might like.

Tires: The g code is sliced for [FlexiLight](#), which prints very nicely. But you can use any of the softer flex TPU materials for the tires. For the foaming material I've scaled the tires to 99% to fit easier into the wheel cut-outs.

Mechanical parts: Are basically sliced with 0.2mm QUALITY settings, but with an additional 3rd perimeter.

Here the right choice of the PLA material is important! PLA properties are changing with the colour and the rule is: The more pigment or glitter-thingy in it, the softer and weaker it gets. Less pigment on the other hand means stiffer and tougher, but also more brittle. Clear filaments work, but tend to break early on hard shocks. White, black

and the very most uni-colours work good. On silver it depends, many are too weak, but I found some on a clear base which even became my favourite.

Bill of material

Drive settings:

50mm Ducted Fan or similar
40A Electronic Speed Controller or similar
XT 60 connectors
2600mAh 4S Battery or similar
16AWG wire black
Gold Connectors
Shrink tube

Servos, RC, etc.:

Radio system, with at least 9 channels or more
8x 12g servo MG90S
ESP8266 micro controller as servo way extender or suitable servo with 180° travel.
3x 80cm servo lead extension
4x 20cm servo lead extension
1x carbon rod 0,8mm × 3,0mm × 577mm
2x carbon rod 0,8mm × 3,0mm × 675mm
4x carbon rod, 1,5mm × 6,0mm × 1220mm
2x carbon rod 3,0mm × 10mm × 287mm
1x Ø 3mm spring steel wire, ca. 20cm (from your local dealer)
1x Ø 4mm × 0.5mm brass tube, ca. 20cm
4x Ø 1.0mm steel pushrod, 100cm
1x Ø 1.2mm steel pushrod, ca. 30cm
6x push rod connectors
1x M2 threaded ball joint
10mm Velcro strip for Li-Po battery
Rubber bands
CA glue - medium or similar medium viscosity CA glue
Activator for CA glue or similar
Silicone sealant

Screws:

- 4x Ø 2mm×10mm, self tapping countersunk
- 1x M2 nut

- 4x M2×8mm, countersunk
- 4x M2×10mm, countersunk
- 2x M2×16mm, countersunk
- 5x M2×20mm, countersunk
- 8x M2×10mm, cylinder
- 6x M2×16mm, cylinder
- 2x M2×20mm, cylinder
- 1x M2,5×18mm, flat hat
- 2x M3×16mm, countersunk
- 4x M3×28mm, countersunk
- 2x M3×8mm, cylinder
- 1x M3×12mm, cylinder
- 2x M3×16mm, cylinder
- 3x M3×18mm, cylinder
- 2x M3×20mm, cylinder
- 1x M3×28mm, cylinder for drive-shaft
- 3x M3×36mm, cylinder
- 2x M3×30mm, DIN912 cylinder
- 1x M4×20mm, nylon screw
- 1x M4, nylon nut
- 2x M5×16mm, cylinder
- 2x M5×20mm, cylinder
- 4x M5 nut
- 1x M5×20mm, nylon screw
- 1x M5, nylon nut
- 1x M6×16mm, cylinder
- 1x M6 nut

Not in the mood for gathering? Get your complete [screw set here!](#)

Tools:

- Snap knife
- Sanding paper to smoothen light weight PLA
- Draw blade to smoothen standard PLA
- Screwdrivers and Allen keys
- Pliers (a Z-bending pliers is very helpful)
- Tweezers
- Bench vice
- Rotary-tool (Dremel) or angle-grinder (to cut the steel wires)
- Hand drill
- Drills: 1.0mm (a very long one is helpful), 1.5mm, 2.0mm, 3,0mm
- Glass plate as plane surface, when glueing
- Tissue for wiping off CA glue
- Masking tape

Assembly instructions

General notes: All wing and the rear fuselage parts have tubes for the carbon rods. Give very good care to clean this tubes from any debris that may have come in from printing. (Especially the light-weight filaments tend to stringing and the parts should be printed individual to reduce travel moves to a minimum.)

Make sure you can move the carbon rods without noteworthy friction in their tubes for installation. Smaller cloggings will go out, when pushing rods through, more serious ones can be cleared, by sanding one side of a carbon rod to a guillotine shaped blade, hardened with CA glue it will help you to work your way through the part. Don't use excessive force, remove rod as soon as it starts to camp, rotate and retry. Once made through, grip the short end of the rod to a bench vice, and start carefully moving the part up and down on its rod. At first only pull and rotate rod in bench vice, after a few moves the carbon will heat up and thereby notably widen the tube. Now go fore and back, holding on the rods other end by hand and carefully increase speed. Continue until sufficient movement is gained. But(!) this should not be necessary when printed properly with the correct settings. Reduce foaming factor by lowering the printing temperature, in case you face clamping nevertheless.

Installing the pushrod connectors: First adopt the adequate hole in the servo horn to \varnothing 2mm and put the first washer and the connector on, then the second washer. Now, before finally installing the M2 nut, use a strong pliers or the bench vice to carefully squeeze the it a little. -Not much, just enough to make it lock on, but not rip the thread.

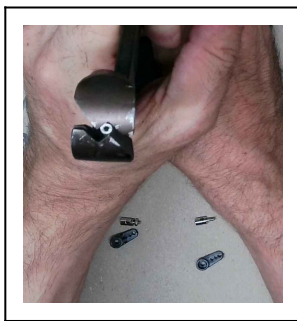

Apply pressure carefully and check in between, until you gained some practice. It's easy to spoil some nuts and maybe a thread this way, but on the other hand, it's much more reliable than locking varnish, way cheaper than M2 locking nuts and easier to do, than you might guess! The nut is only made of fairly soft stainless steel and you'll need very few deformation.

Part 1: The fuselage

3D-prints:

- DG-600_fuselage_1 to fuselage_8
- DG-600_v-stabilizer_1 and _2
- DG-600_rudder_1 and _2
- DG-600_h-stabilizer_1 and _2 by (_left and _right)
- DG-600_elevator_1 and _2 by (_left and _right)
- DG-600_elevator-servo-lid_1 and _2
- DG-600_nut-cover_1 and _2
- DG-600_rudder-servo-stand
- DG-600_main-frame_front and _rear
- DG-600_frame_skin_front and _rear
- 2x DG-600_gear-door-hinge
- 2x DG-600_gear-door-hinge_hooked
- DG-600_hinge-set (elevator and rudder hinges)
- DG-600_rudder-horn

RC- and standard parts:

- 2x servo MG90S
- servo extension cord, 20cm and 80 cm
- 4x fuselage enforcement tube, 20mm (from \varnothing 4mm x 0,5mm brass tube)
- 2x gear door axle, \varnothing 1,2mm x 80mm spring steel wire
- elevator pushrod, \varnothing 1,2mm x 180mm steel wire, z-bend one side
- rudder pushrod, \varnothing 1,0mm x ca. 640mm steel wire, z-bend one side
- 2x pushrod connector
- carbon rod (0,8mm x 1,5mm), 2pcs 675mm, 1pcs 577mm

Screws:

- 4x \varnothing 2mm x 10mm, self-taping, countersunk
- 4x M2 x 8mm, countersunk
- 2x M2 x 16mm, countersunk
- 4x M2 x 16mm, cylinder
- 2x M2 x 20mm, cylinder
- 1x M4 x 20mm, nylon with nut
- 1x M5 x 20mm, nylon with nut
- 2x M5 x 16mm, cylinder with nut
- 1x M6 x 16mm, cylinder with nut

1. Start assembling fuselage_1, _2 and _3. Align opposing parts and use some masking tape to temporarily fix. Then apply glue to the gap and press the parts together. Wipe off excess glue immediately, then cure. Remove tape again and use glue and accelerator to close the remaining gaps.

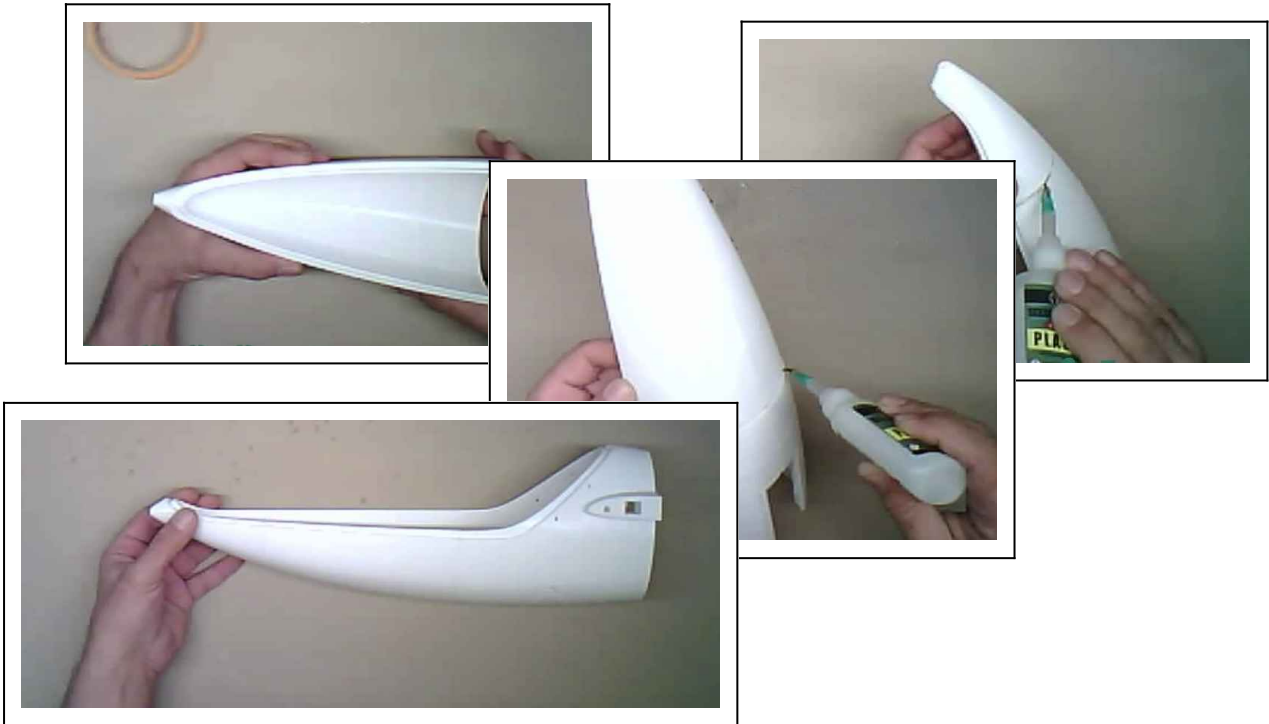

2. Now attach the skins to the main frames. Use a glass plate or mirror and place main frames flat sides onto, then place skin over care for good, even seat before applying glue. Wipe off excess glue and cure. (If stuck to glass slide in snap knife blade from the side to separate.)

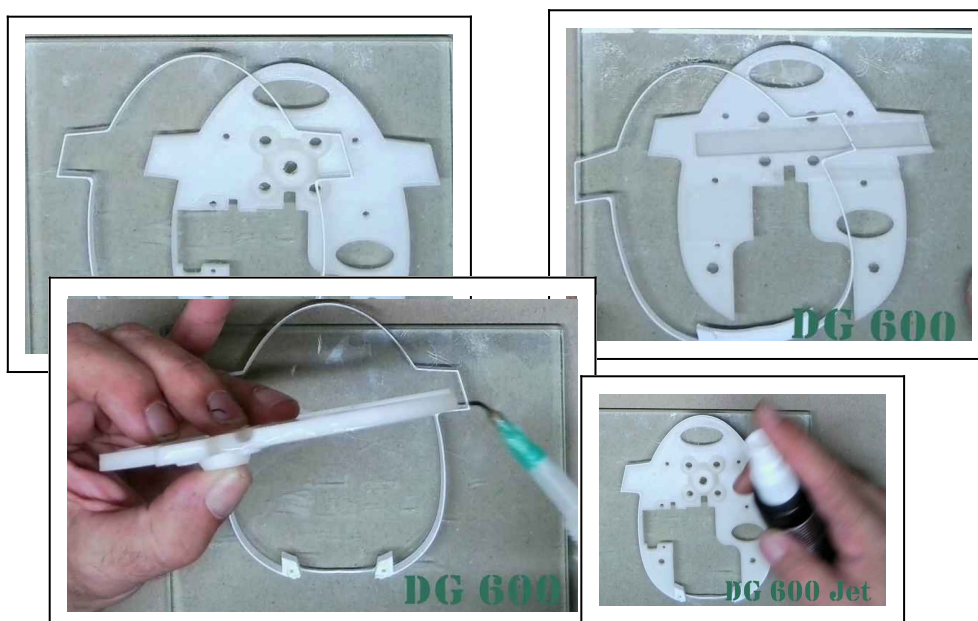

3. Glue M5 nuts to rear main frame and secure with the M5 screws, then position the frame and glue it to rear fuselage section.



4. Repeat with the front frame and fuselage_3 and set in the M6 nut with some silicone sealant and secure with the M6 screw until later.

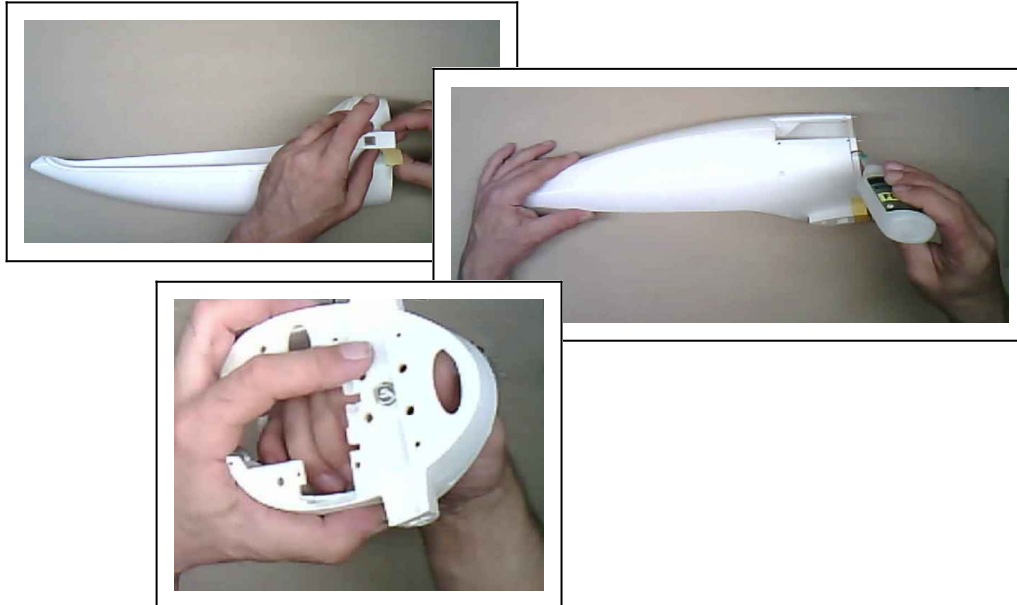

5. Begin with the rear fuselage section by sticking in the three carbon rods to fuselage_4. Take a look at the cut-outs to assure the long rods reached their final position, then cure.

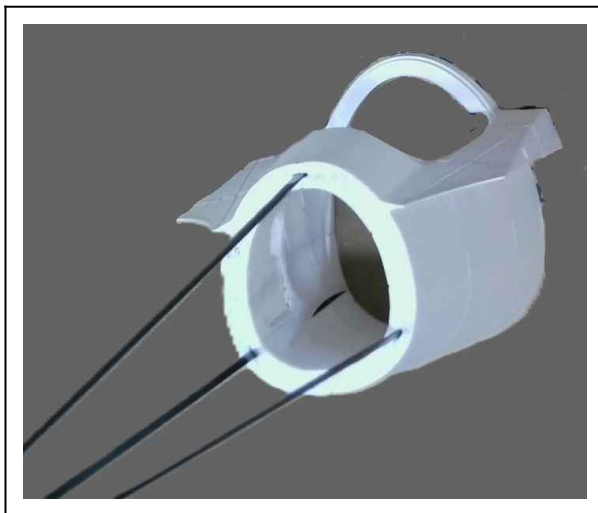

6. Now line up fuselage_5 onto the rods, push parts together and mark end positions, then move part up again, over the markings just made.

Attention! Make very sure you can move the fuselage part easily and without force on the rods. In case not, rework before glueing! If already clamping without glue, it will jam in the next step and spoil the rear section and the carbon rods!

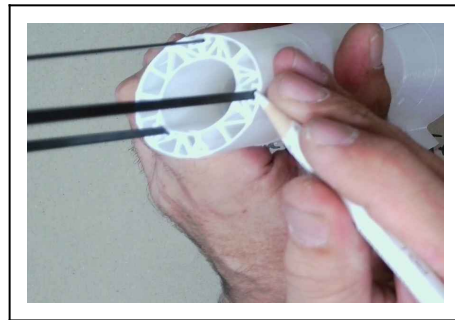
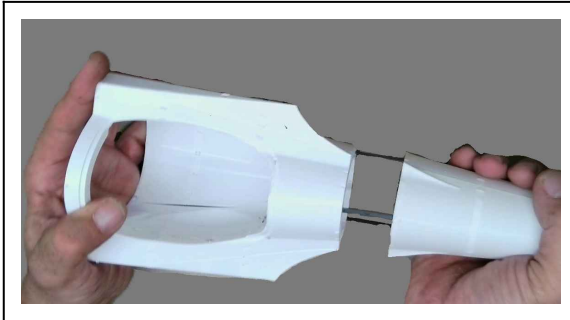

7. Careful apply glue to the face side of the assembly and the marked area on the rods. Avoid the free fuselage-part or other areas of the rods!

Take the assembly in one hand and hold the free fuselage part with the other. **Now slide on the part in a single move, do it uninterrupted and at a good pace and don't get stuck!**

Immediately wipe off excess glue, then aim along the fuselage to check and adjust linearity and angularity before curing. Repeat this procedure until fuselage_8. (The following pictures show processing of fuselage_6.)

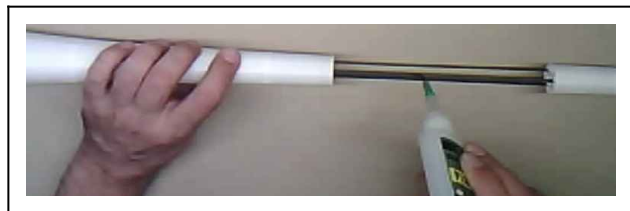

Congratulations! You've just mastered the most challenging part of the build, the rest is peanuts.

8. Insert the door hinges to their cut-outs and secure with the $\varnothing 1,2\text{mm} \times 80\text{mm}$ steel wire, then use M5 $\times 16\text{mm}$ screws to join front and rear section

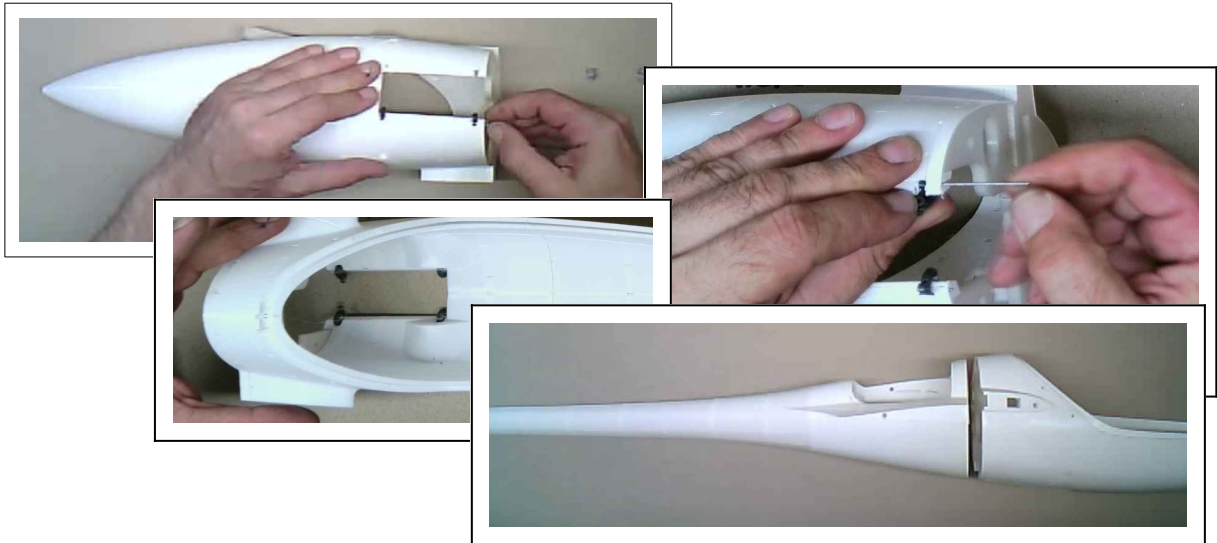

9. Now glue in the four $\varnothing 4\text{mm} \times 0,5\text{mm}$ brass tubes and sand them flush to the surface.

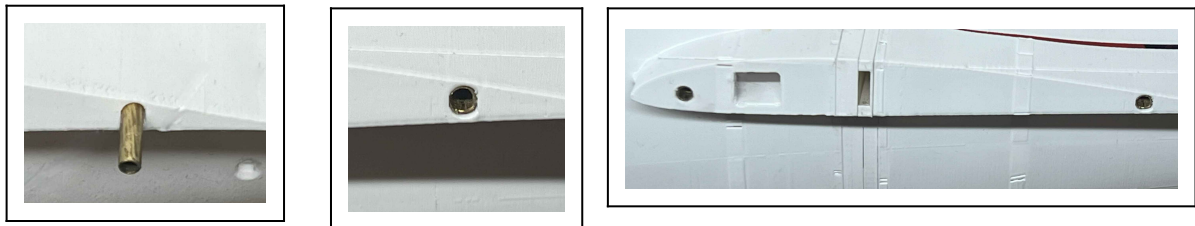

10. The connection between tailboom and vertical stabilizer does not offer much space and has to bear the carbon spars in prior, so unfortunately there is not enough space to guide a plugged servo extension-cord trough the duct inside. But lucky us, there is a solder-free solution: The premature servo installation! So please follow this order:

- I. Guide the servo cord through duct in stabilizer_1, let plug hang out.
- II. Install the servo into its pocket in the stabilizer.
- III. Attach the extension cord to the servo cable coming from stabilizer.
- IV. Guide extension to the fuselage centre.

Now go on with the next step.

(No worries in case you glued the fin too early! Get your solder stuff, chop off plugs and connect extension and servo cable. Now guide in and install the servo.)

11. Glue together v_stabilizer_1 and _2, align and cure, then apply CA to the face sides and the remaining rods and slide on the stabilizer. Carefully aim and check angularity of tail, then cure and finally check tail connection for gaps and seal with glue.

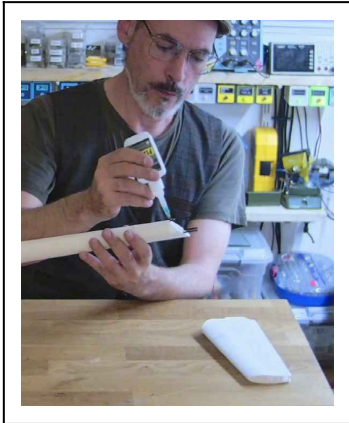

12. (Tip: Use glass plate and a ruler or wood strip as ledge to position the following light-weight parts, like done before with the frame skins.)
Start by assembling the four parts of the horizontal stabilizer and generate a left and a right elevator side. Use the M2 x 20mm to fix the outer hinges to the elevator and M2 x 16mm for the inner ones, check movement, then join the elevator halves. Now apply a tiny amount of glue to pockets in the stabilizer, then insert the hinges, starting from inner to outer. Aim from sides for clearance and alignment to the strak.

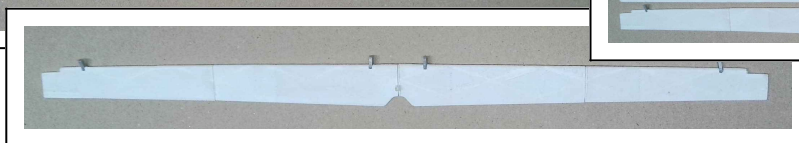
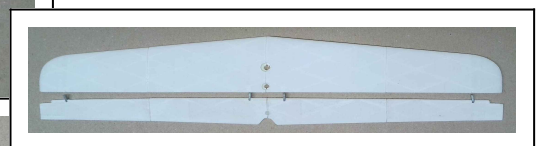
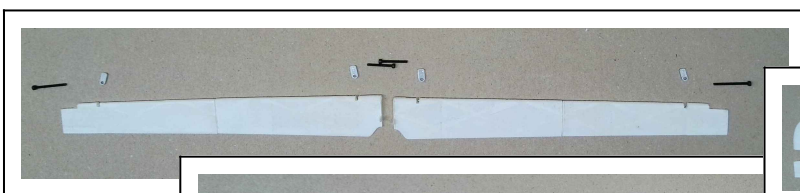
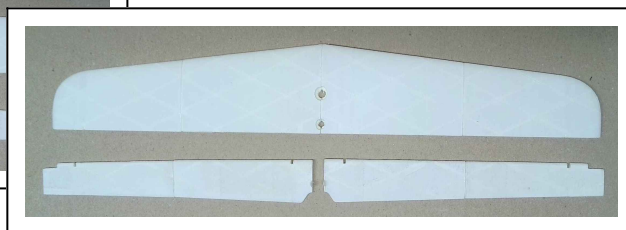
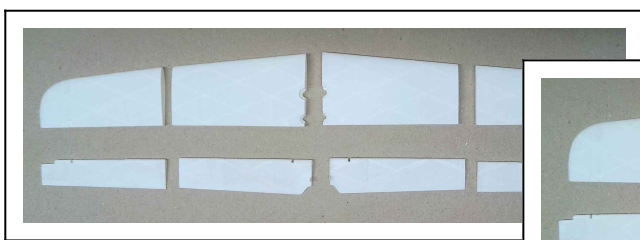

13. Join rudder halves and glue in the horn, then insert the hinges into their pockets and secure with M2 x 16mm cylinder screws. Tighten only lightly and make sure, the hinge can move freely. (There is a cut-out for a third hinge in the middle, but it showed, it's not necessary and will only bring weight to the worst place. Anyway the hinge is included with the set, so you can install if desired. Use M2x12mm then.)

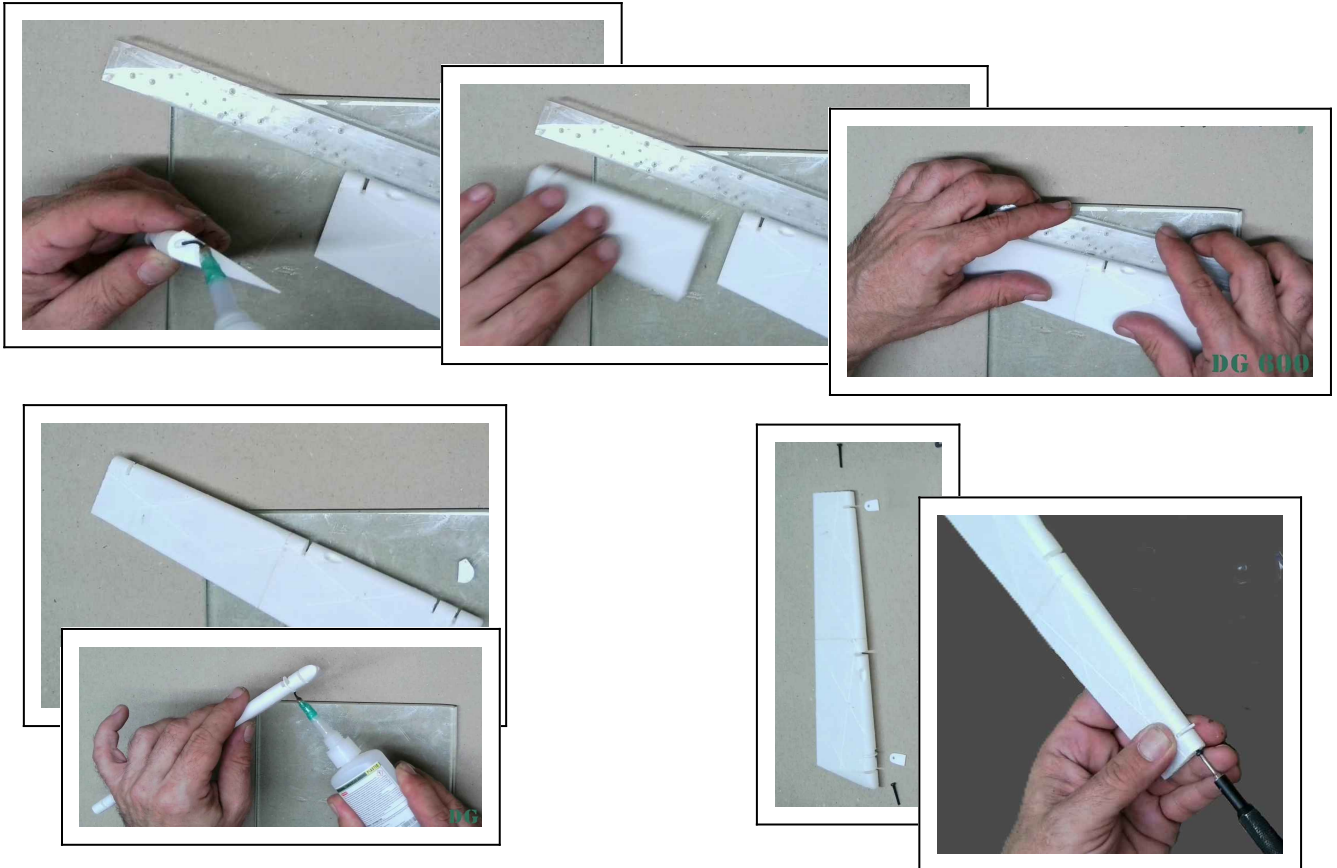

14. Now apply a tiny amount of glue into the opposite pockets in the v-stabilizer and guide hinges in. Aim from top for centred position and sufficient clearance and again check ease of move.



15. Install the pushrod connector to the third hole in the servo horn, then mount the servo to its support and set unit in the pocket inside the fuselage. Secure with M2 x 16mm countersunk screws.

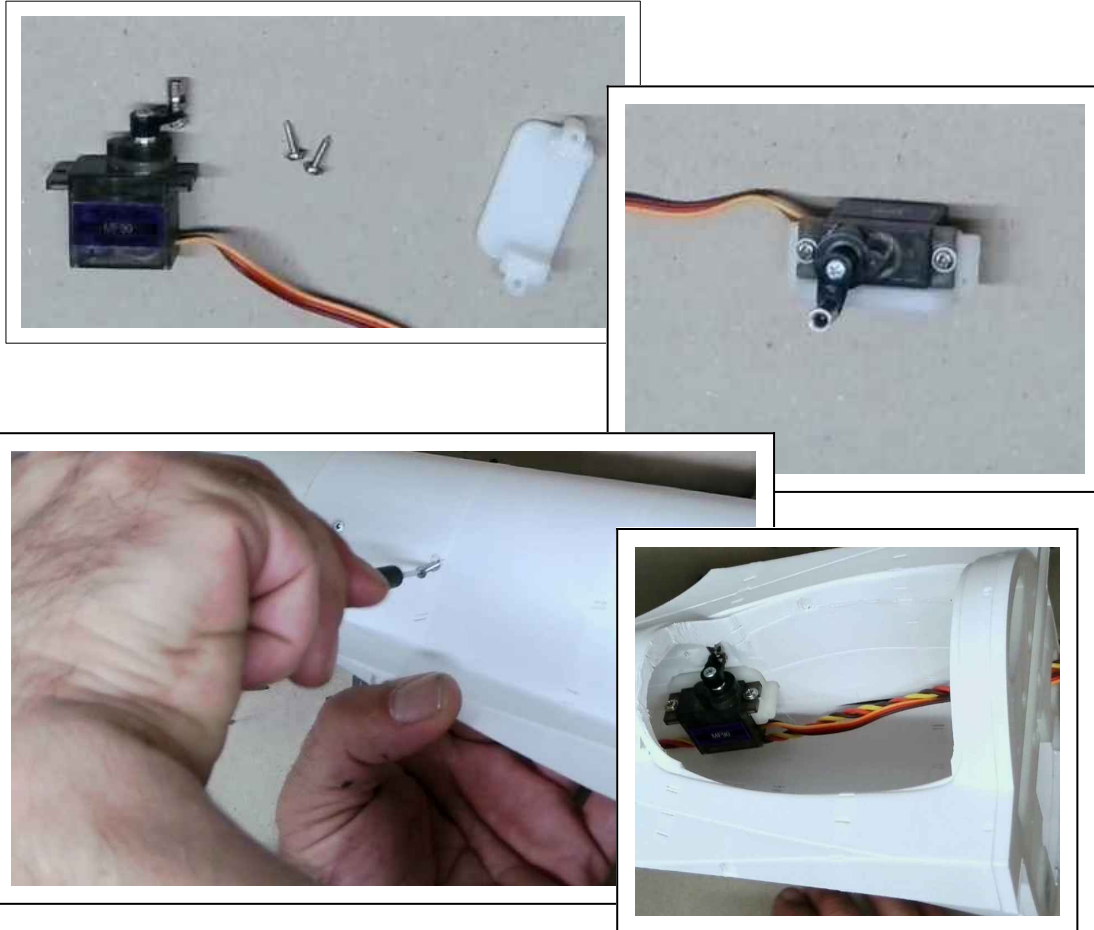

Now loosen the rudder again, link the pushrod to and guide the rod through its tube to the servo. Adopt length and shorten pushrod with very few overlap (approx. 1-2mm). Fix rudder again and tighten the locking screw through the assembly opening with a long Allen key. Finally power up and check function.

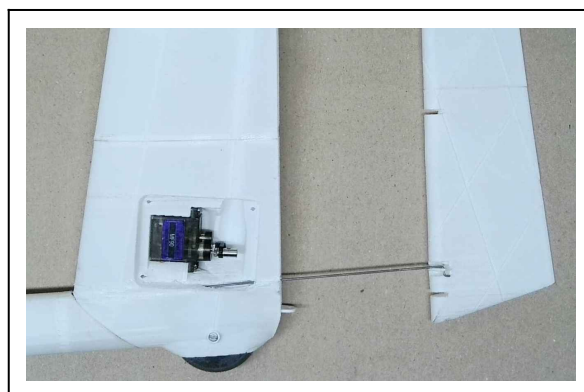

16. Now insert the nylon nuts to their pockets and secure with the nut_covers, then install pushrod connector to the second hole in the elevator servo horn and shorten horn.

Link pushrod to elevator and guide it to the servo, then fix the h-stabilizer with the nylon screws.

Finally join the two parts of the servo lid and attach with the \varnothing 2mm x 10mm self-taping screws, power up servo and check function.

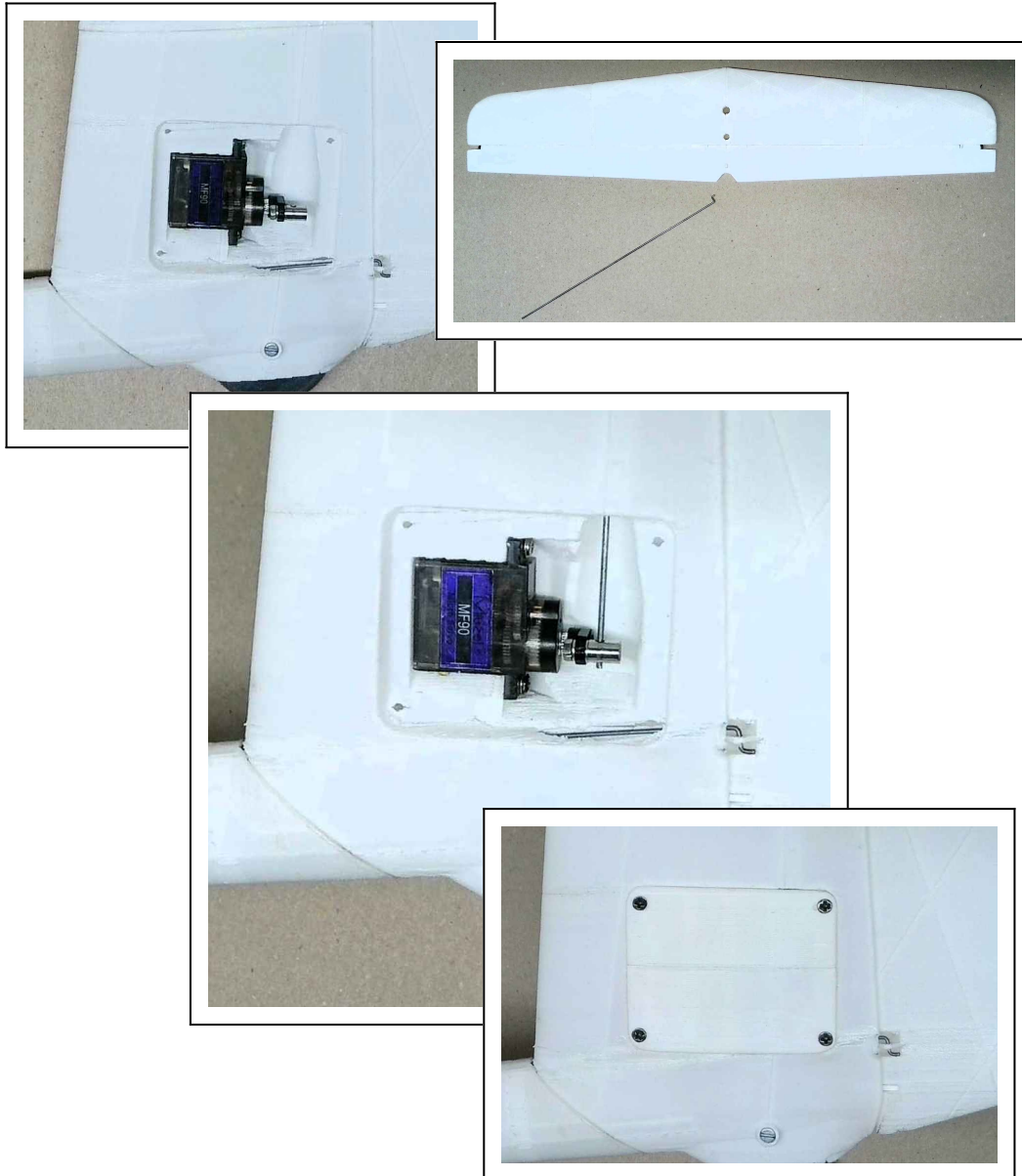

Part 2: The Wing

3D-prints:

- DG-600_wing_1 to _12, _left and _right side
- DG-600_flap_1 to _4, _left and _right side
- DG-600_aileron_1 to _3, _left and _right side
- DG-600_hinge-set, all remaining hinges and horns

RC- and standard parts:

- 4x servo MG90S
- 2x 80cm servo lead extension
- 2x 20cm servo lead extension
- 2x flap axle, \varnothing 1,0mm \times 742mm steel wire
- 2x aileron axle, \varnothing 1,0mm \times 500mm steel wire
- 2x flap pushrod, \varnothing 1,0mm \times ca. 90mm steel wire, z-bend one side
- 2x aileron pushrod, \varnothing 1,0mm \times ca. 70mm steel wire, z-bend one side
- 4x pushrod connector
- 4x fitting pin, \varnothing 3mm \times 40mm spring steel wire
- 4x main spar, 1,5mm \times 6,0mm \times 1200mm carbon rod
- 2x wing connector, 3,0mm \times 10mm \times 287mm carbon rod

1. Glue the main spars into the openings of wing_1, make sure the ends are flush with wing_1.



Then basically use the same method as described in step 5 to 7 of the fuselage section. So slide down wing_2, mark its position on the spars, then move up again, until its past the markings made.

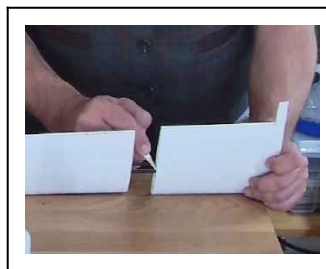
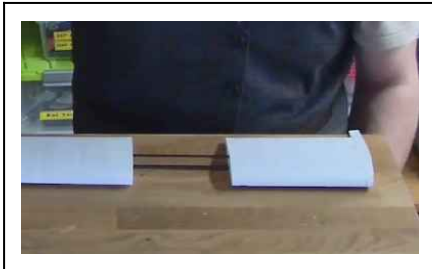

Apply glue to face side of wing assembly and marked area on the spars, then slide down the part in a single move, do it completely, uninterrupted and at a good pace and don't get stuck! Immediately wipe off excess glue, care for good match of leading and trailing edges, then place on a glass plate and position trailing edge with the ledge when curing. Aim along the trailing edge and check for correct alignment.



2. Proceed with wing_3 and bring it in position, mark it on the spars, but then also slide in the wing connector, make sure it is all the way down and mark its position as well, remove and continue to glue wing_3, check and cure as usual. Now don't hesitate and apply glue to the marked area on the wing connector and let some run into its pocket, post slide in the connector, again and check settlement before curing. Take good care to get a rigid connection between main spars and the wing connector! There is a slightly bigger gap in bottom of wing_2, to enable you to run in some more glue, if needed.

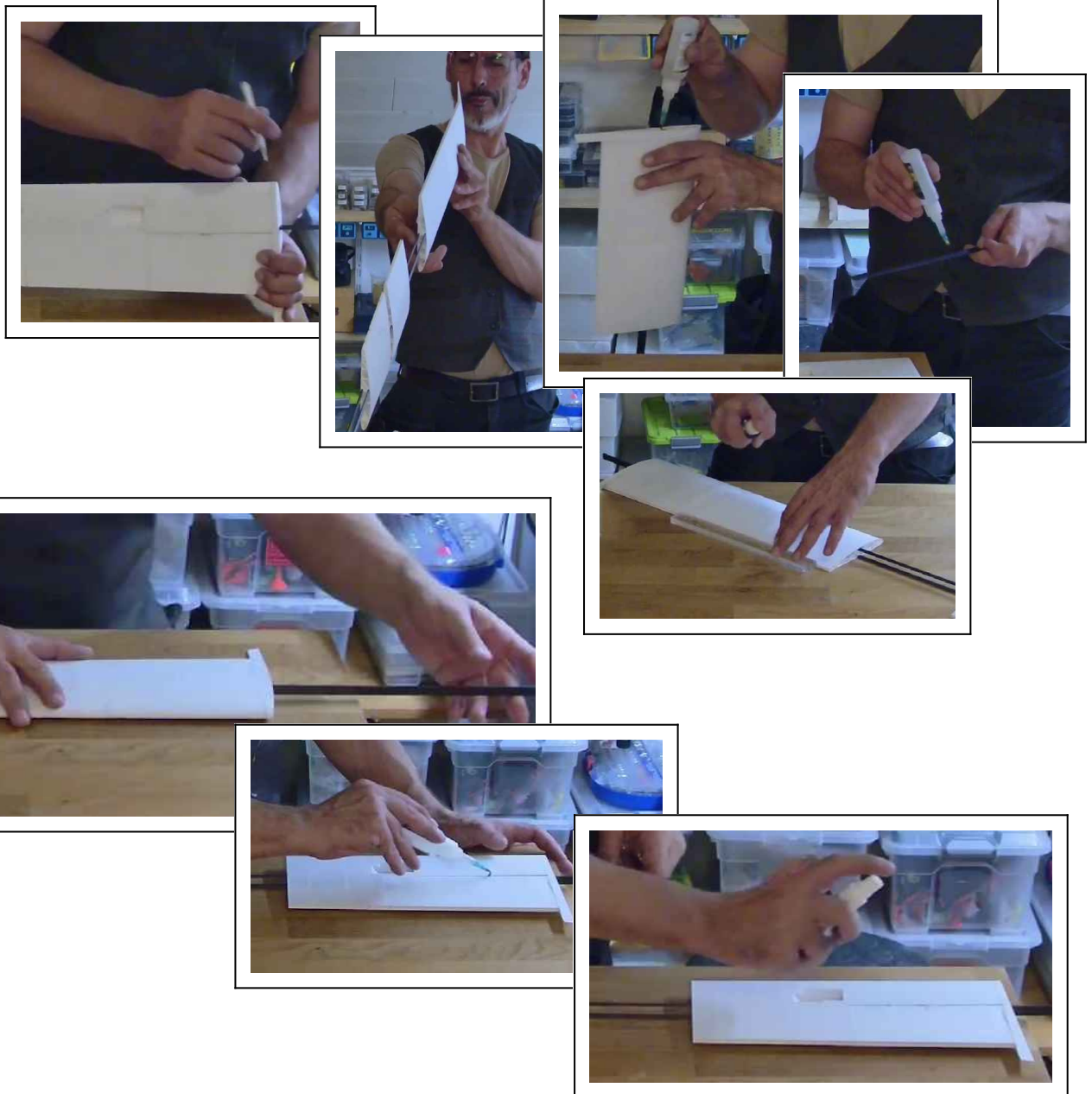

3. Continue with wing_4 until wing_10, always having an eye on alignment and evenness of the wing, then attach the winglet wing_12 to wing_11 with the help of two short pieces of 1,75mm filament, if necessary shorten the carbon struts before glueing on wing_11.



4. Now line up aileron and flap parts together with hinges and horns onto their 1mm steel axles, first fix the horns, then join parts one by one on the glass plate. Make sure not to jam the hinges!

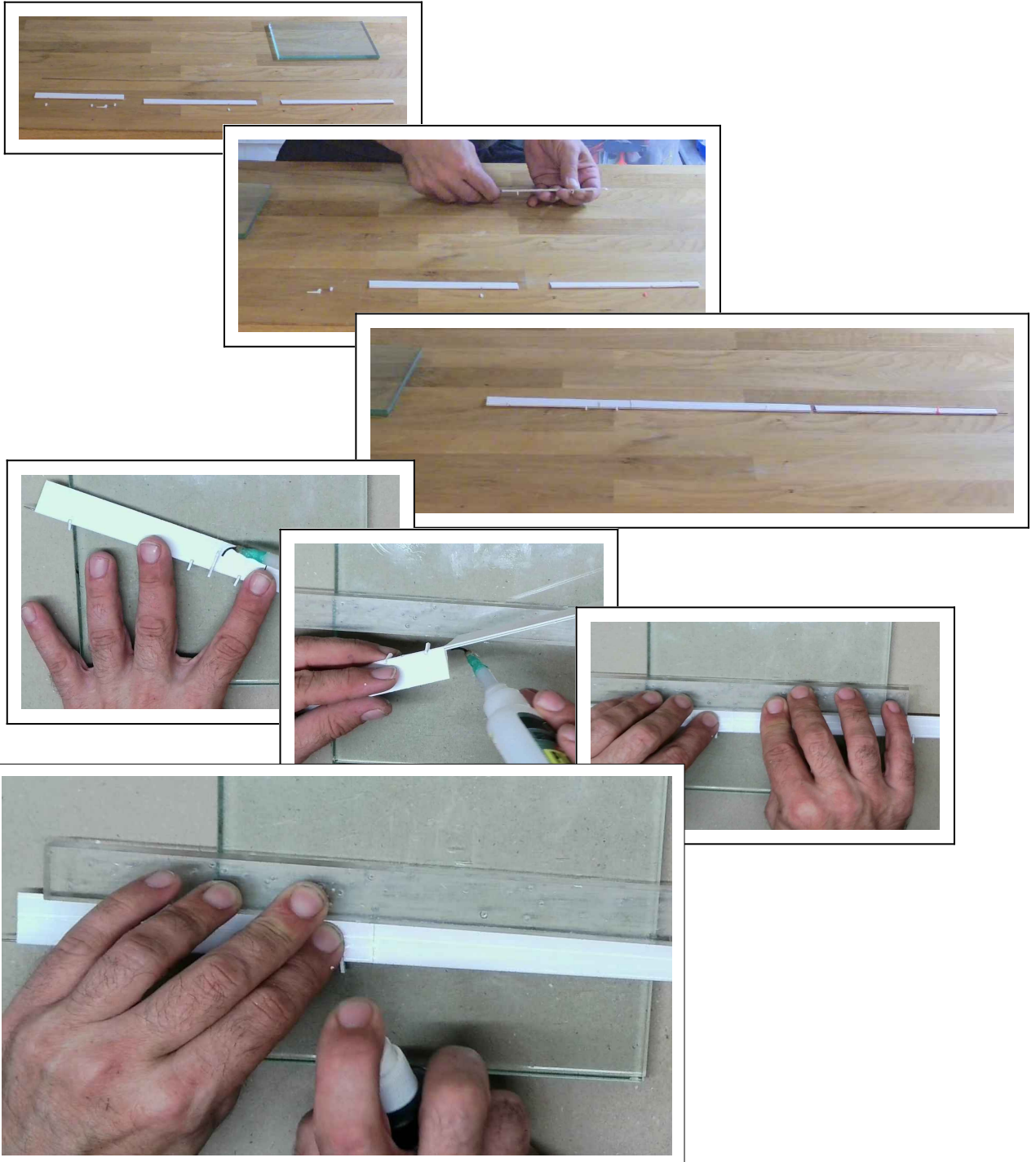

5. Clear the 1mm axle bushings in wing_1 and wing_11, then guide the flap axle through the bushing in wing_1 and fit in the flap.

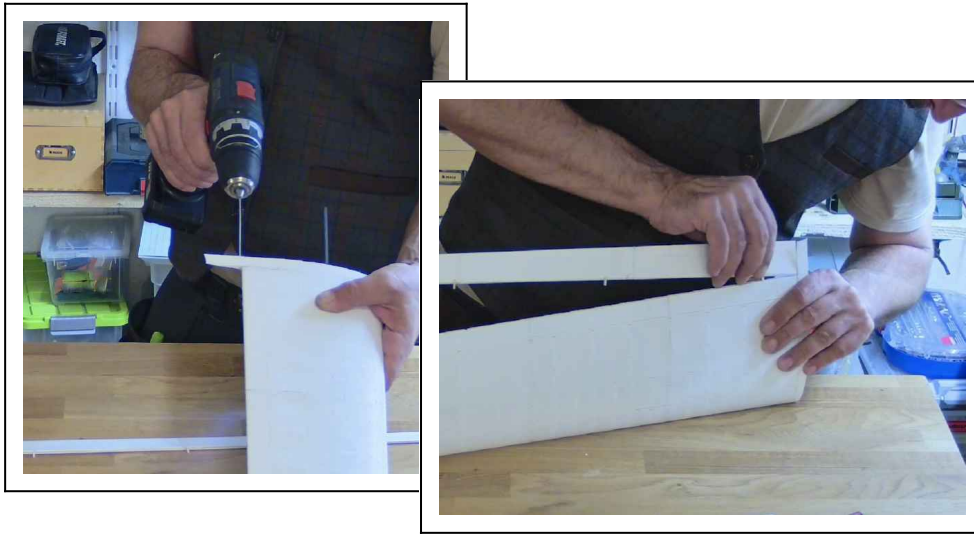

6. If everything is snug, lift flap a bit to bring a tiny amount of glue into the first three closed pockets. Put back in the hinges and care for good alignment to strak and clearance inside the groove, then cure and continue with the last hinge of the opposite site. In this way work through the hinges one by one.



7. Now continue with aileron and guide axle first in the wing tip and then into the flap (bend aileron a bit), then glue hinges in the same way. As always, keep a good eye on alignment and clearance!

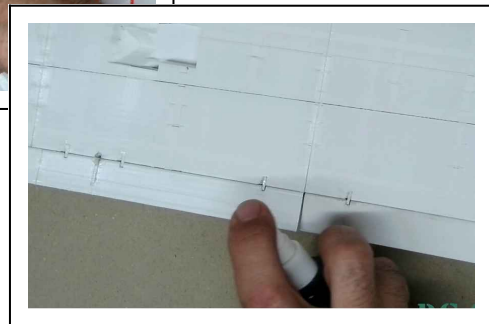
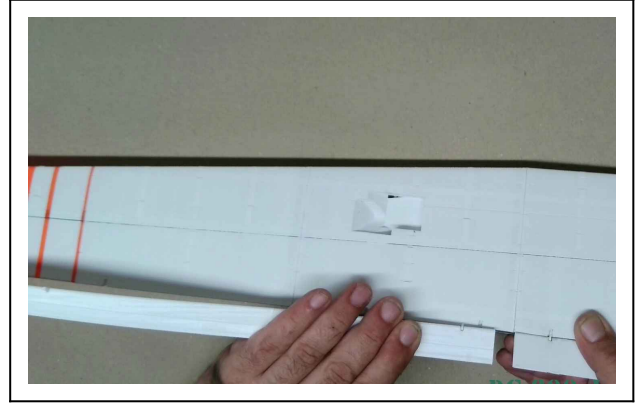
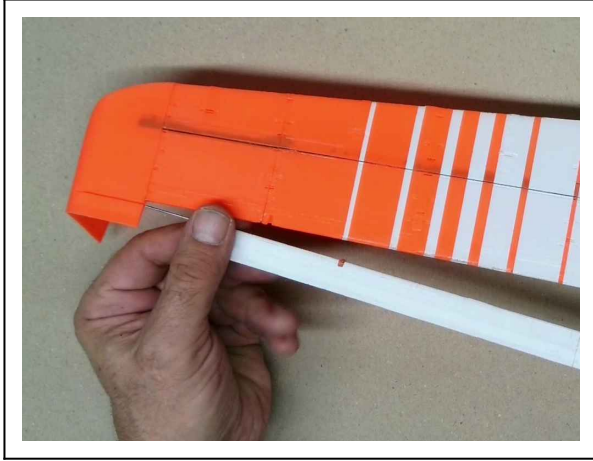

8. Cut away the rear mounting lashes of the MG90S servos (opposite to the drive side) and plug the 80cm extension cord to the aileron servo.

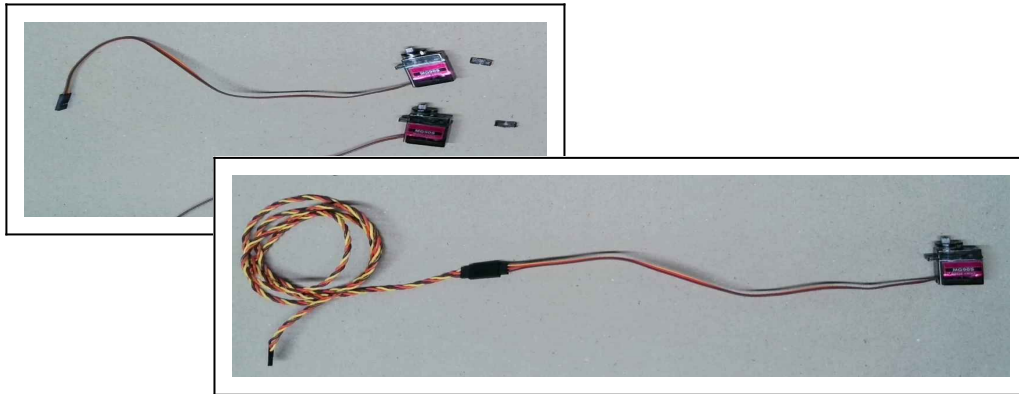

9. Take some 1mm steel wire (>80cm), insert its tip into the extension plug from the back and guide the cable to the wing centre. Now bring the cable and the servo into their pocket and fix the servo with one screw and a spot of silicone or hot glue to the other side of the servo and the wall.

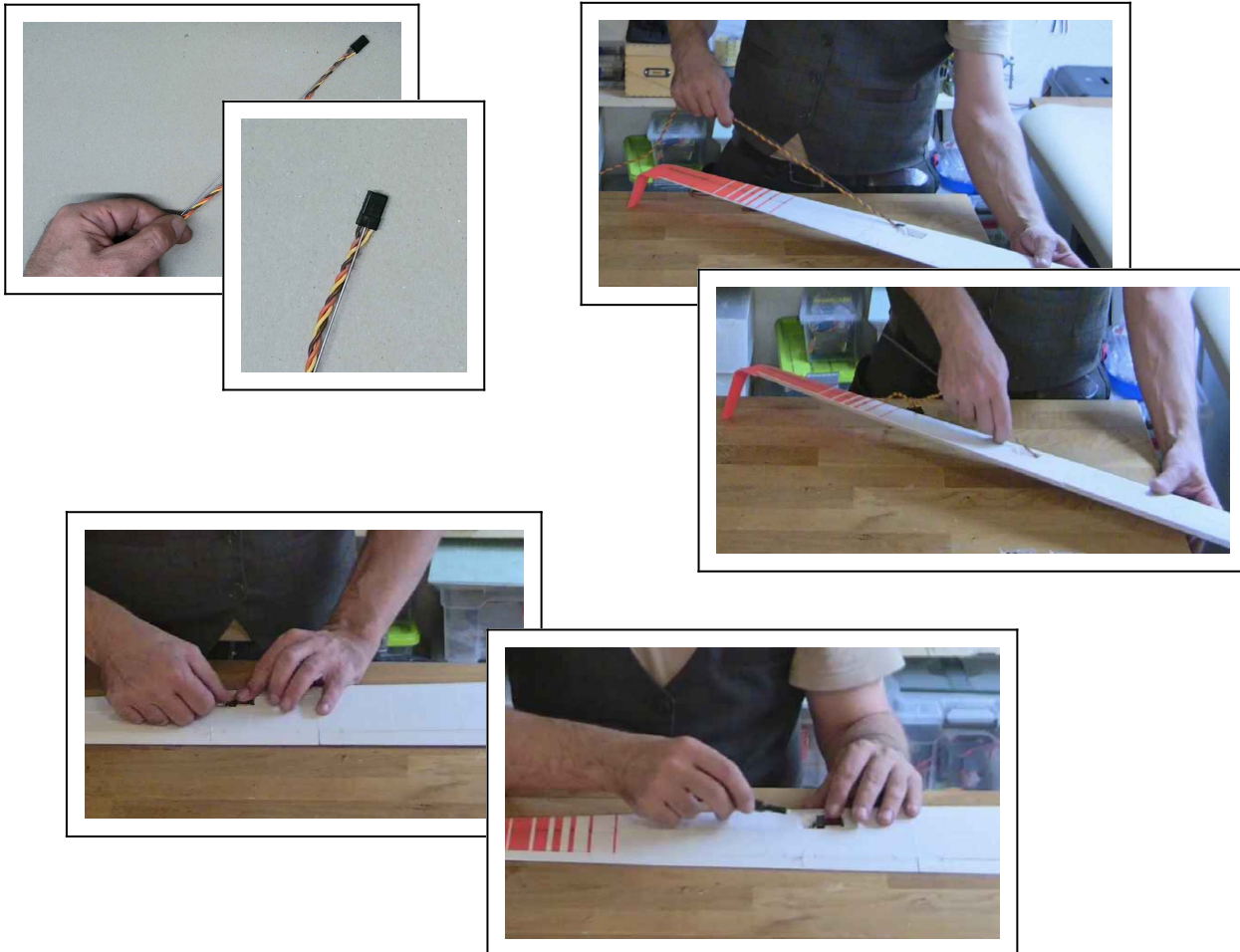

10. Install the flap servo and pay attention to guide the aileron servo cord correctly into its duct when doing.

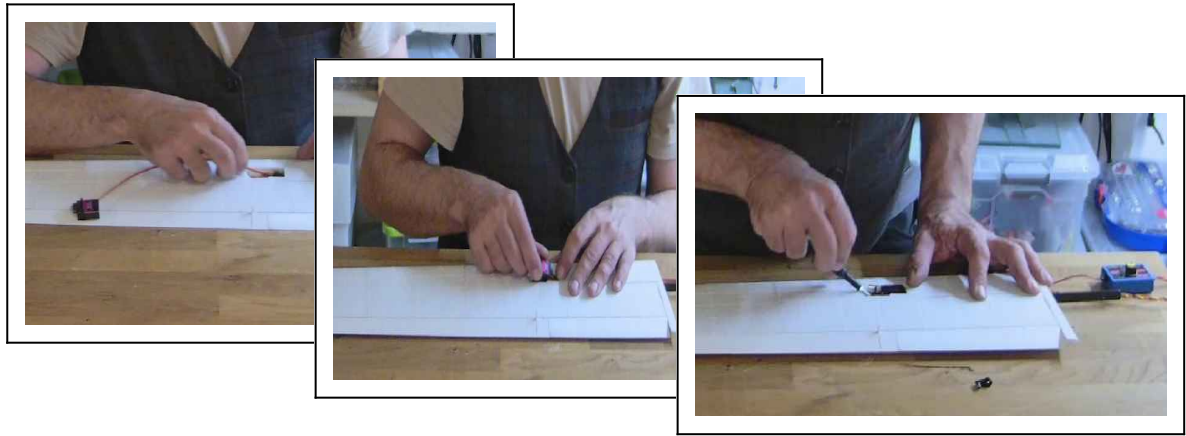

11. Install the pushrod connectors to the third hole of each servo horn. Link the z-bends to the aileron and flap horns and guide the pushrods into their connectors, then tighten the set screws.

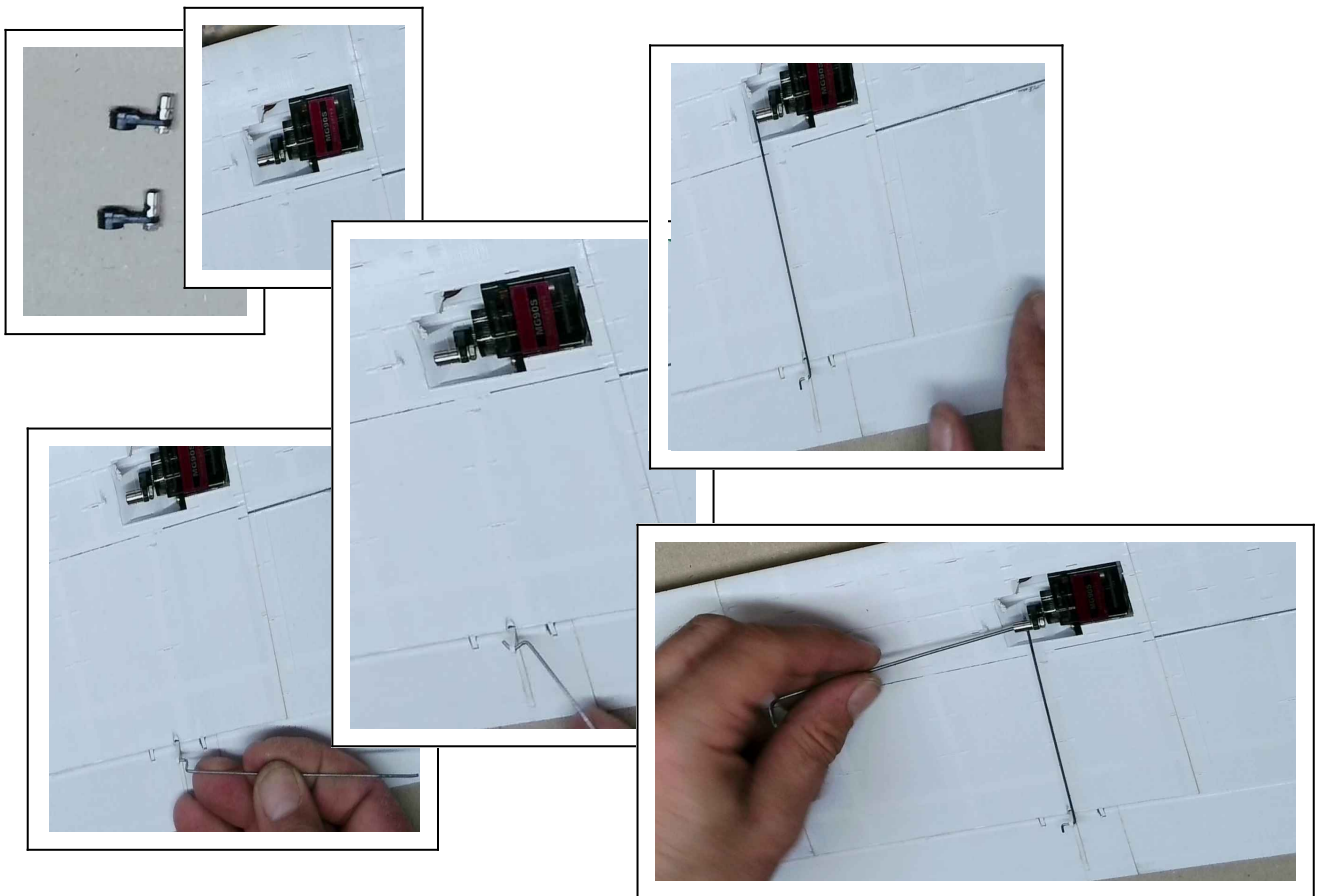

12. Apply a chamfer to the \varnothing 3mm fitting pins and glue them into the holes of wing_1.

Now use pliers to add a 90° bend to the end of the flap axle in fit into its wing cut-out.

Temporarily mount the wing and check alignment with the fuselage, now power up your servos and check function.

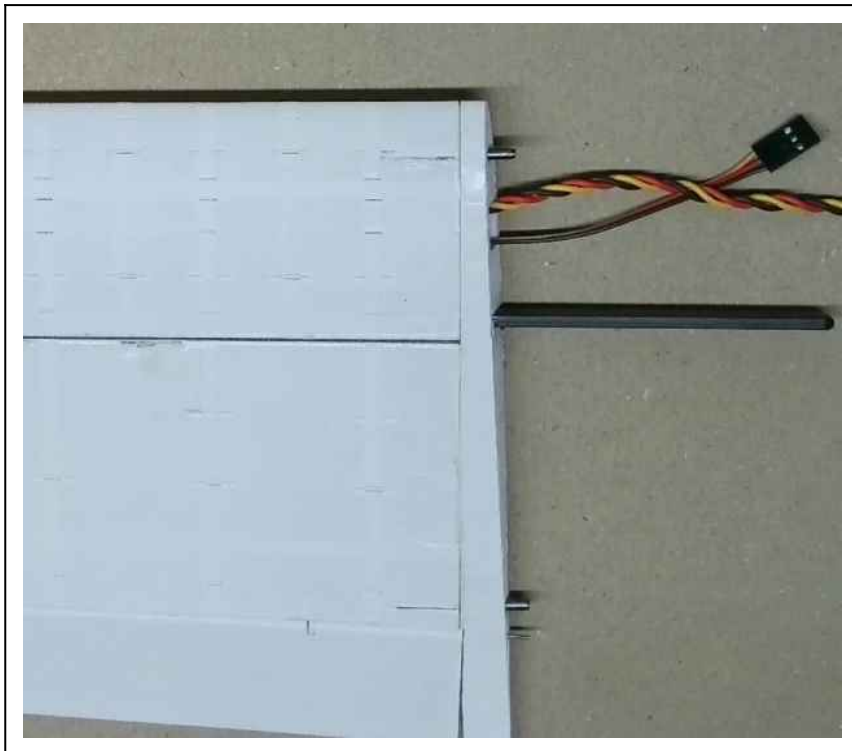
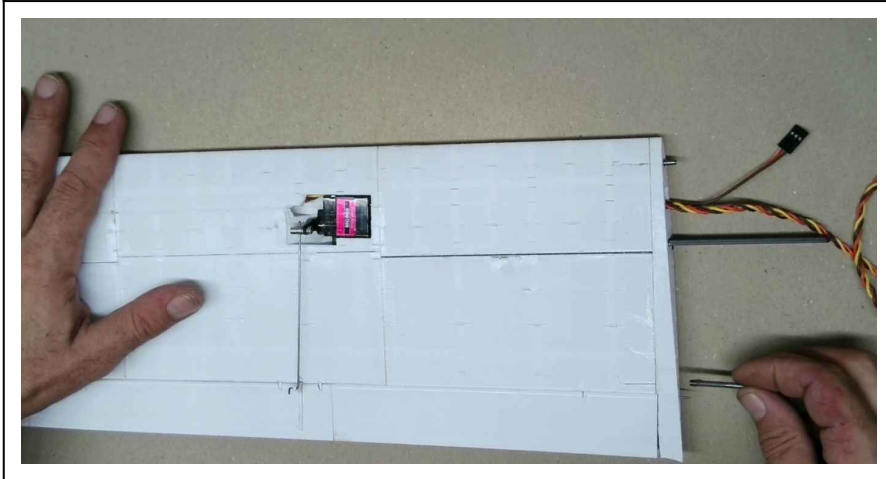

Part 3: The ducted fan unit

3D-prints:

- DG-600_EDF-mount-block
- DG-600_EDF-lower-arm_left and _right
- DG-600_EDF-upper-arm_L&R
- DG-600_EDF-housing
- DG-600_EDF-engine-cover
- DG-600_EDF-servo-bracket_1 and _2
- DG-600_EDF-servo-clevis

RC- and standard parts:

- 1x 50mm EDF unit
- 3x motor extension cord with \varnothing 3mm gold plugs m/f
- 1x servo MG90S with way extender, or suitable servo with 180° travel
- 1x M2 threaded ball joint

Screws:

- 1x M2 × 20mm thread, or chop from M2 screw
- 4x M2 × 10mm, countersunk
- 2x M2 × 20mm, countersunk
- 3x M2 × 10mm, cylinder
- 2x M2 × 16mm, cylinder
- 2x M3 × 16mm, countersunk
- 1x M3 × 30mm, countersunk
- 2x M3 × 8mm, cylinder
- 5x M3 × 18mm, cylinder
- 2x M3 × 20mm, cylinder

1. Open the hole in the right lower arm to 2mm and install the ball head. Then use M2 thread, the printed servo clevis and the ball joint capsule to assemble the servo linkage and attach it to the servo horns utmost position with a M2 x 10mm cylinder screw.

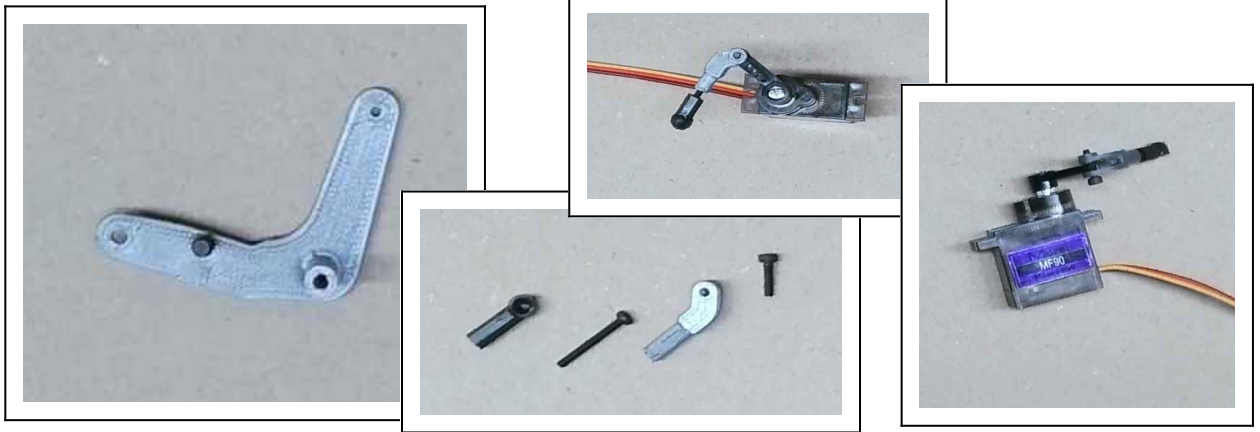

2. Connect left and right lower arm with the M3 x 30mm countersunk screw, press on plane surface, when tightening the screw.

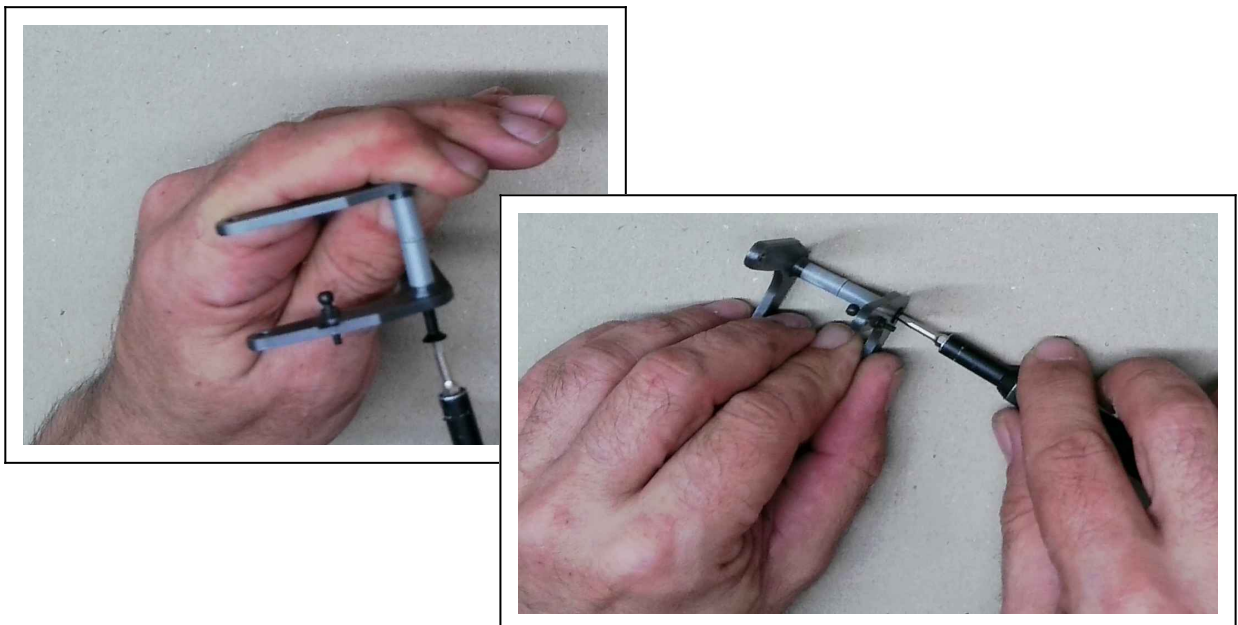

- Now set arms into the slots of the mount block and use M3 × 8mm cylinder to link lower and M3 × 16mm countersunk for upper arms. Tighten very carefully and mind ease of move.

Move unit by hand and look for any obstruction. It is supposed to fold and unfold all the way with minimum effort. Depending on your EDF type, it may be necessary to add a little cut-out the mount block (a hot screwdriver works well).

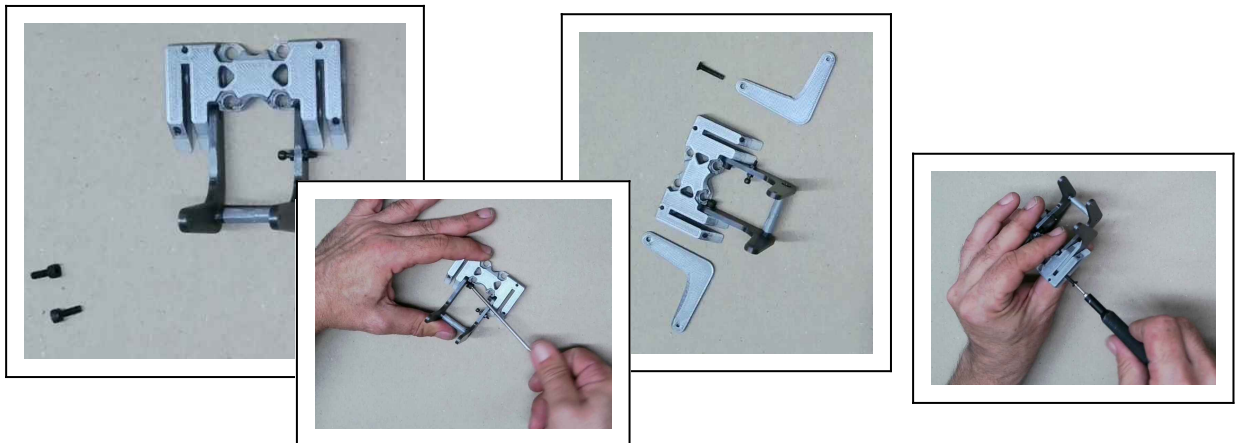

- Insert EDF unit into its housing, then use M2 × 10mm cylinder screws to attach the lower arms and M2 × 16mm cylinder screws for the upper arms. Now use a snap knife and adopt your EDF inlet funnel to the cut outs for the upper arms. Make sure the arms can operate easily and undistracted and tighten screws carefully. Use a drop of CA to the thread if the screw is too loose.

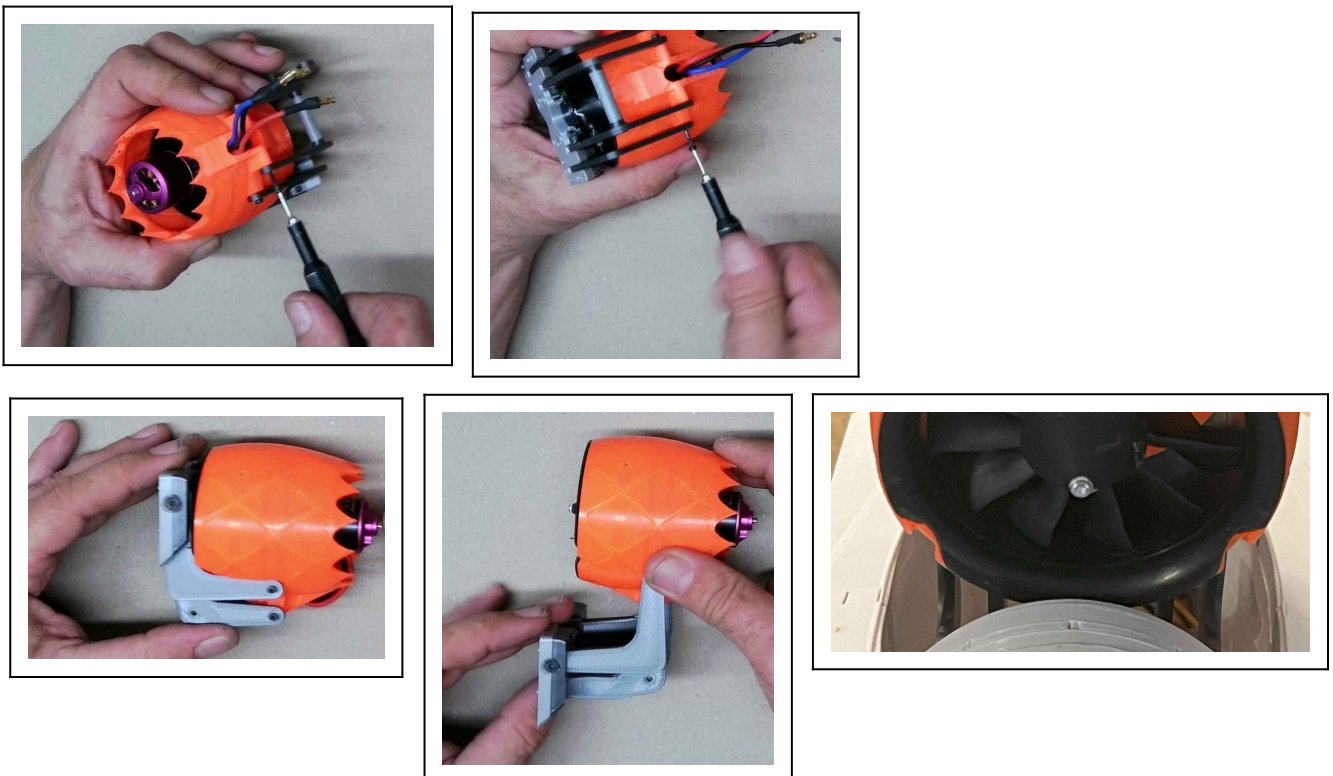

5. Clip on the ball joint with the linkage and servo attached. Now unfold EDF unit and glue the M5 Nuts in the upper pockets. Then insert the mount block to position on the main frame from top and guide servo and cable through the lower cut-out in the main frame to the front. Mind that mount block and main frame contain little fitting pins and holes, so observe snapping into place, then fix with the two M5 screws and three M3x18mm screws.

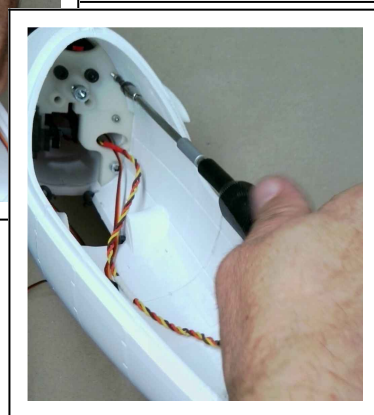
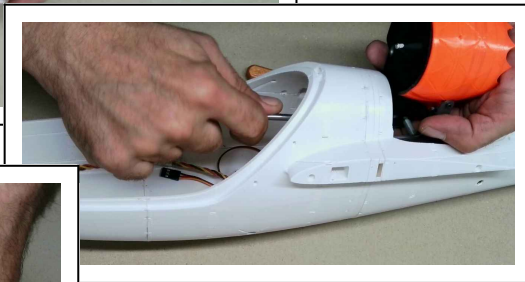
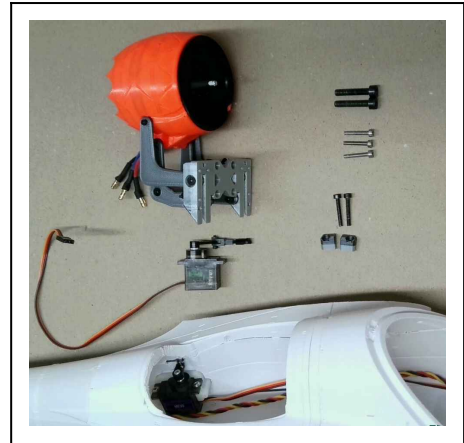
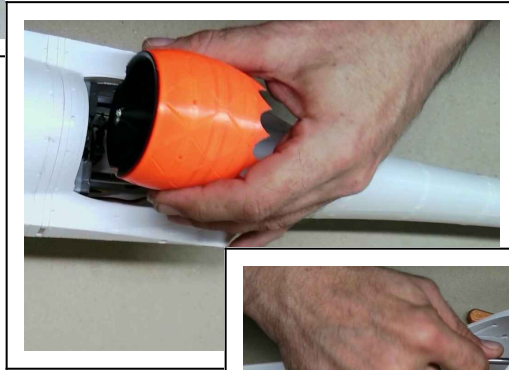
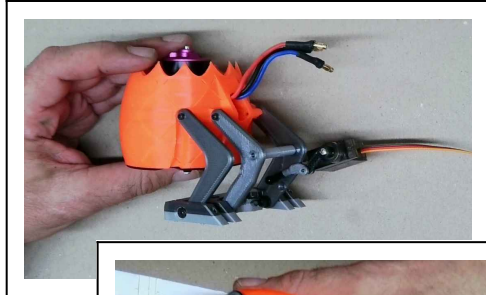

- Equip the two servo brackets with the M3 x 20mm cylinder screws, then bring the servo into its cut-out in the main-frame and use an Allen key to guide in the servo brackets and fix the servo.

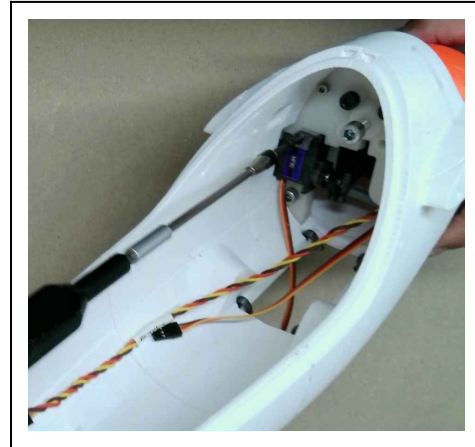

- Connect the ESC extension cables to the fan motor, guide them in an arc, giving enough way to allow undistracted movement of the EDF unit and unite them with the rudder- and elevator servo cable. Now guide the bunch through the hole in the left side of the main-frame and secure carefully inside the engine bay with a strip of duct tape.

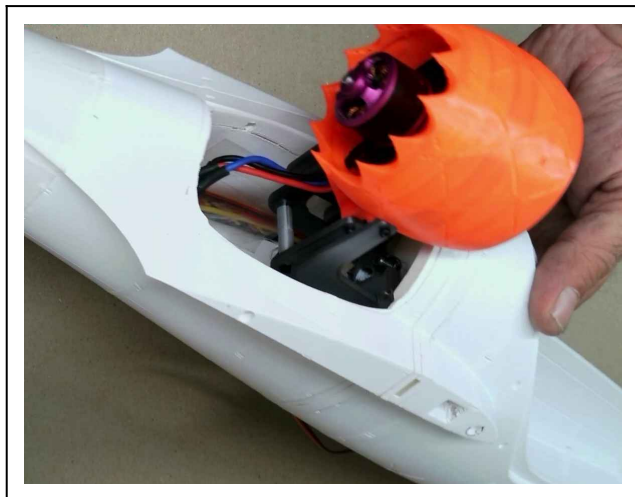

- Attach the way-extender to the EDF servo, power up and check movement of the unit. Make sure the servo hasn't to work against any resistance in its end positions and adjust the length of the linkage accordingly.

9. Finally use the two M2 x 10mm and the M2 x 16mm countersunk screws to install the EDF hood to the housing.

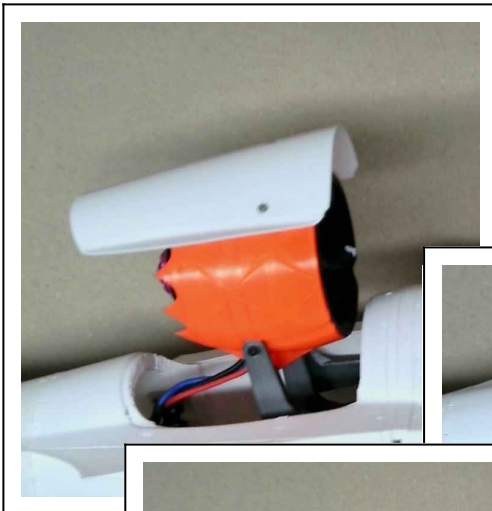
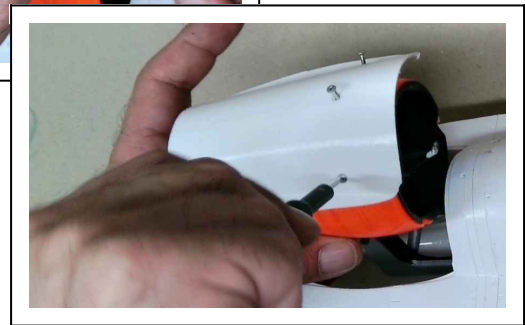
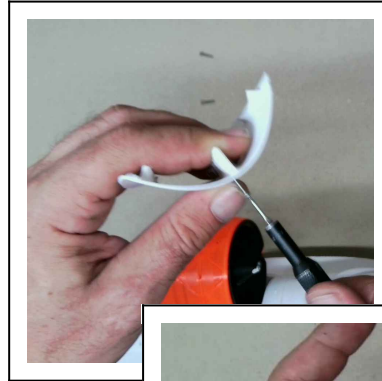

Part 4: The gear

3D-prints:

- DG-600_front-tire, soft TPU or FlexiLight
- DG-600_rear-tire, soft TPU or FlexiLight
- DG-600_gear-damper, soft TPU or FlexiLight
- DG-600_front-rim, 2x
- DG-600_rear-rim, 2x
- DG-600_gear-door_L&R
- DG-600_wheel-lever_left and _right
- DG-600_wheel-guard
- DG-600_gear-body_left and _right
- DG-600_gear_centre-lever
- DG-600_gear-servo-stand, 2x
- DG-600_gear-drive-lever

RC- and standard parts:

- Servo MG90S
- Gear pushrod \varnothing 1,0mm \times 40mm, z-bend on both ends
- Front wheel bushing \varnothing 4,0mm \times 0,5mm, brass tube
- Rubber rings ca. 80mm

Screws:

- 2x M2 \times 10mm, countersunk
- 3x M2 \times 10mm, cylinder
- 2x M2 \times 16mm, cylinder
- 1x M2 nut
- 1x M2,5 \times 18mm, flat hat
- 3x M3 \times 28mm, countersunk
- 1x M3 \times 12mm, cylinder
- 2x M3 \times 18mm, cylinder
- 3x M3 \times 30mm, cylinder
- 3x M3 \times 36mm, cylinder

1. Assemble the rear and front wheel, then adopt length of brass tube and glue it into the front rim.

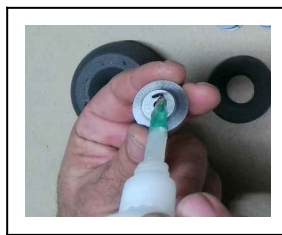
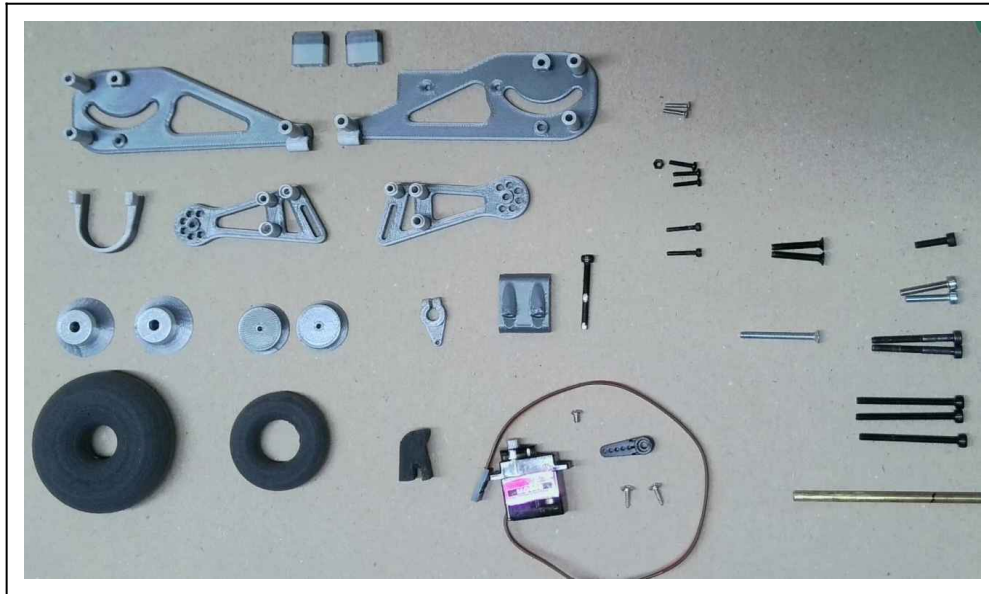

2. Check and clear the rear wheel cut-out for any debris from printing, then insert the rear wheel and secure with the M2,5 screw.

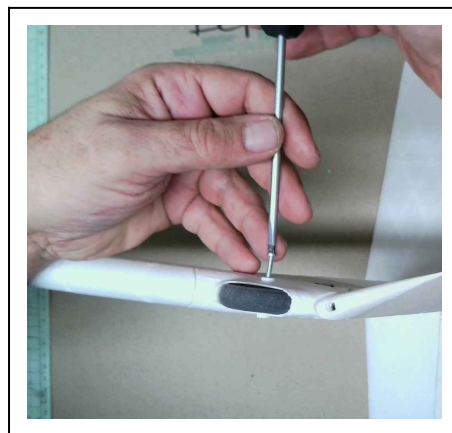

3. Now assemble the wheel levers and install the front wheel with the M3 x 28mm countersunk screws, then attach the wheel guard with two M2 x 10 cylinder screws.



4. Use a long M3 screw as a tap to cut the threads for the M3 x 18mm screws into the centre-lever, then use a 1mm wire to clear the cross-hole from the plastic chips that will appear there from tapping. Prepare the M3 x 28 mm screw with the multi-tool or an angle grinder and apply two notches, according to the drawing to create the gear drive-shaft.

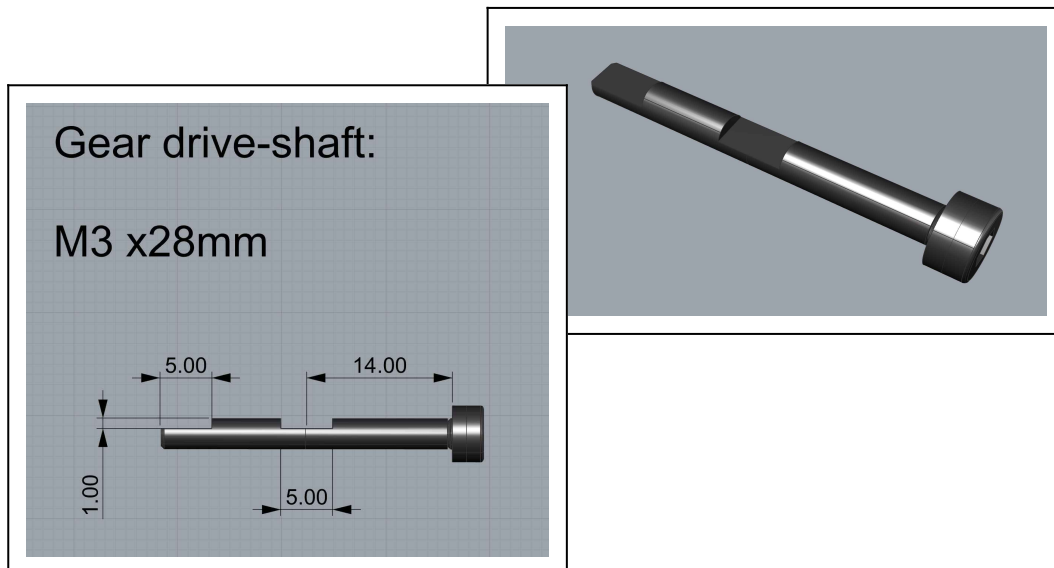

5. Install the servo stands to the left side plate with the M2 × 10mm countersunk screws, then join the two side plates with the M3 × 36mm cylinder screws.

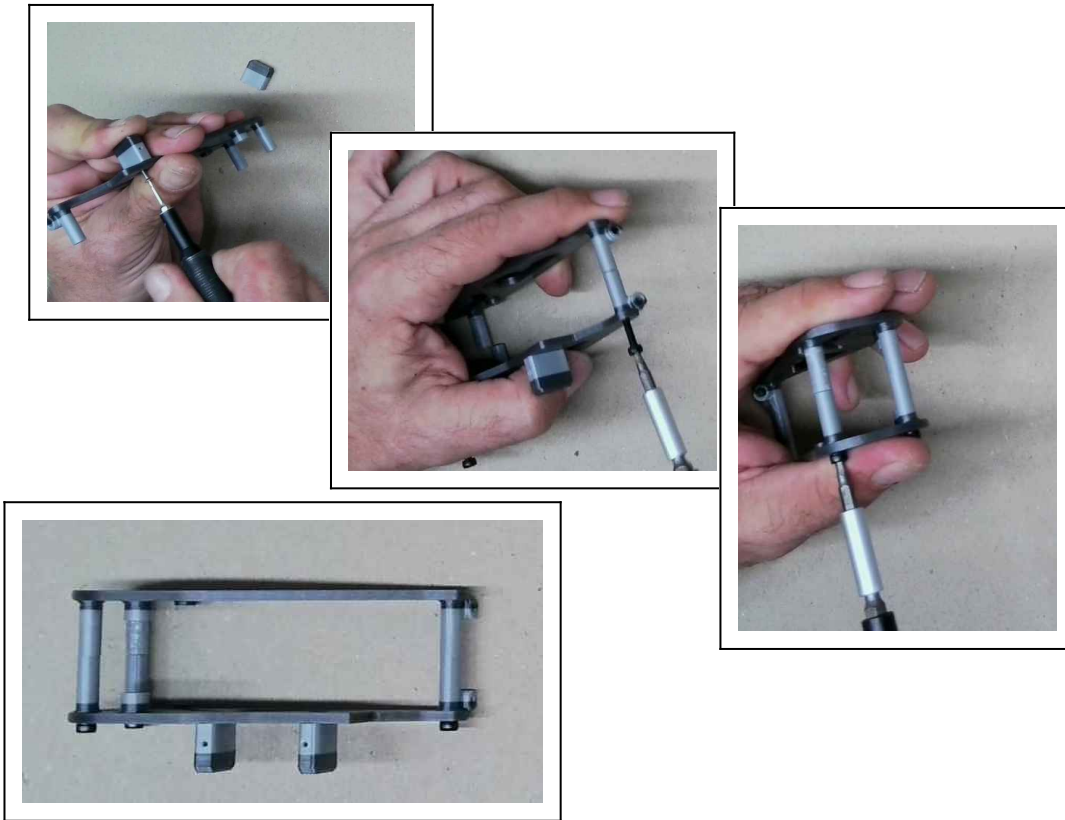

6. Link the centre-lever with the drive-shaft from the left and the M3 × 12mm from right, then lock with the M3 × 18mm screws, but be careful, don't overdo! Now check torque transmission with an Allen key.



7. Now insert the wheel assembly from the bottom, secure temporarily with the M3 x 30mm screws, bring the centre-lever in position (inside the mouth of the smiling whale) and complete the toggle-joint with the M2 x 10mm screws from the outside.



8. Bring the gear in down position and put the drive-lever over the head of the M3 screw, align it to the centre-lever and secure with the M2 x 10mm screw and nut.

Now link the pushrod to lever and servo horn and install servo. Power up and check unit for function, finally glue on the TPU damper.

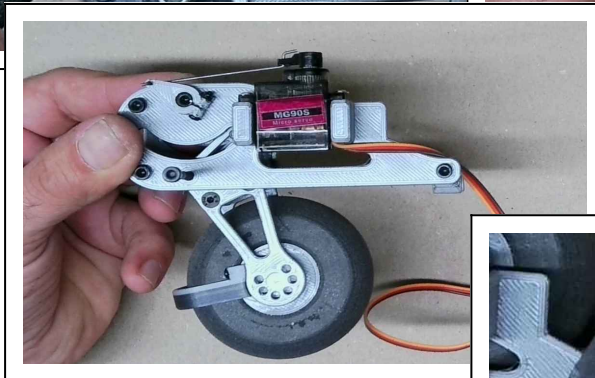
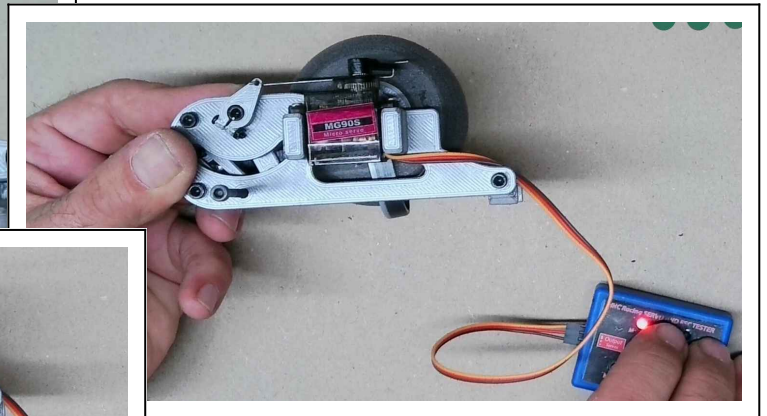
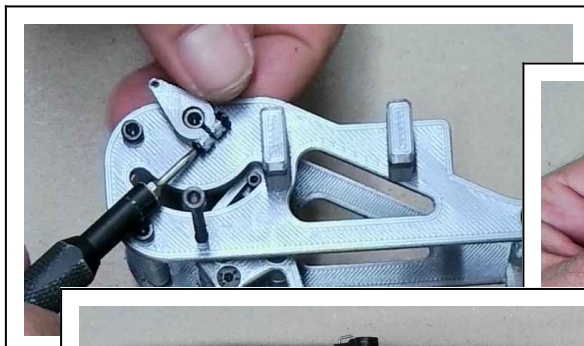

9. Remove the M3 × 30mm screws and insert the gear unit from top into its position in the fuselage. Now insert the M3 screws from outside the fuselage again, carefully guiding them to their holes in the side-plates and the wheel bar, then tighten screws only lightly and check for function again.

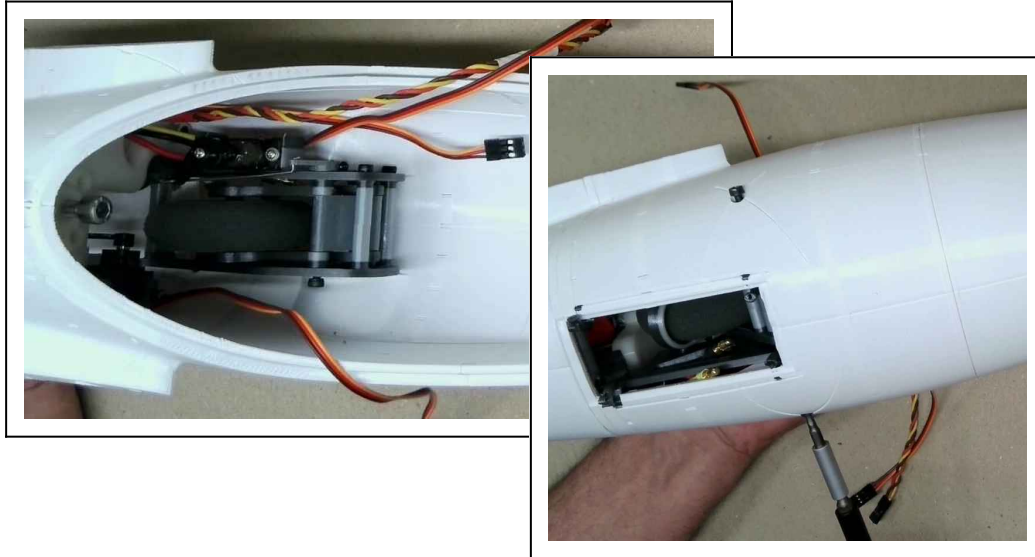

10. Turn over the fuselage and install the gear-doors with the M2 × 8mm countersunk screws, then drive out the gear and hang in a rubber ring into the rear hinges each, turn back the fuse and guide rings to the central locking screw. Check function and adjust rubber tension by including one or both upper M5 screw heads if necessary.

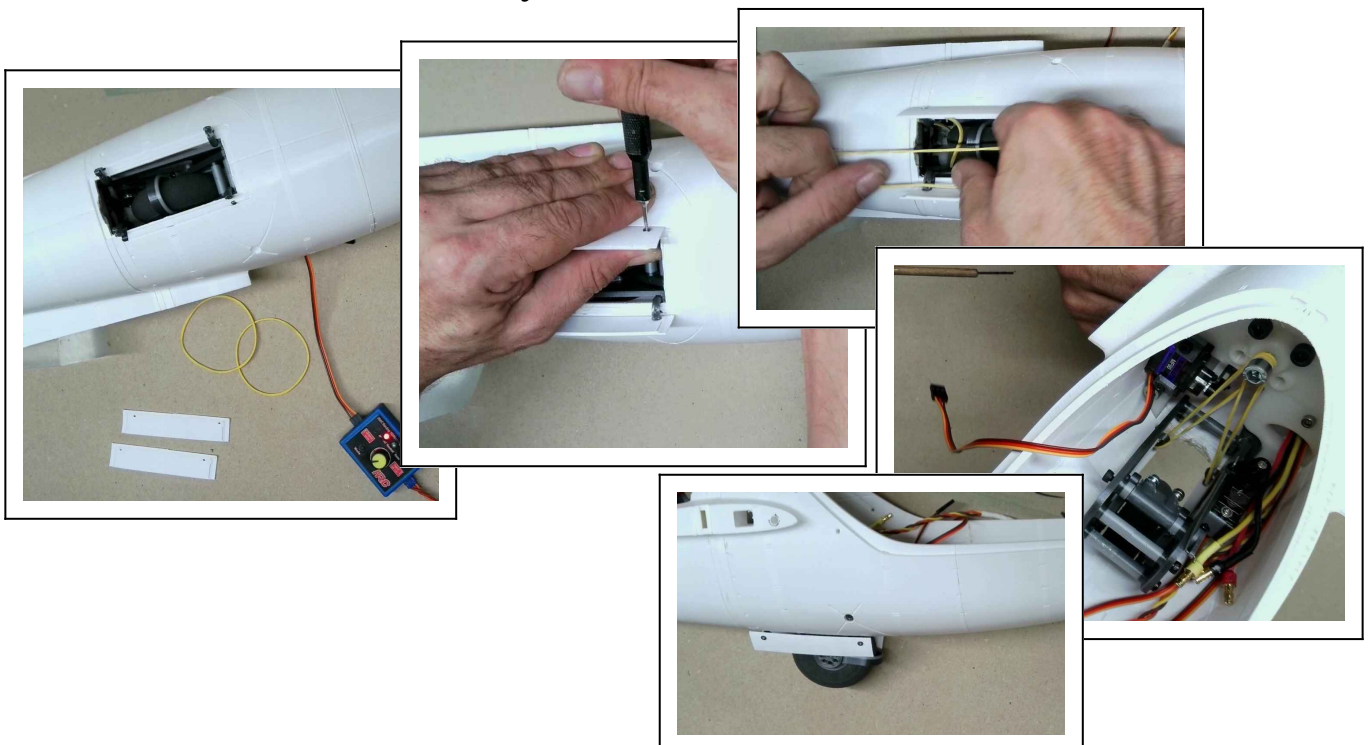

Part 5: The canopy

3D-prints:

- DG-600_canopy-frame_front, _mid 2x and _rear
- DG-600_canopy_front, _mid and _rear
or resin print of the canopy form and a sheet of 1mm Plexi or Vivak ca. 30cm x 50 cm, together with your thermoforming equipment
- DG-600_canopy-hook

1. Pre assemble the canopy frame with masking tape, check alignment, then apply few CA to the connections and cure, remove tape again and glue from other side if necessary.

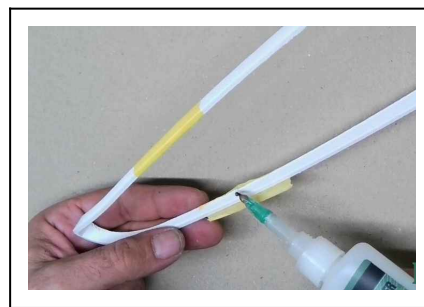
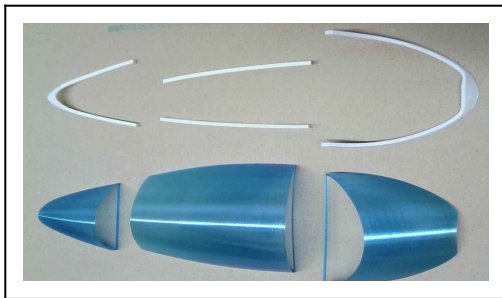

2. Pre assemble the canopy parts, then apply a small line of glue along the joints, wipe off excess glue and allow to evaporate some time before curing to avoid the white glue-shadows. Don't cut away the bars inside yet.

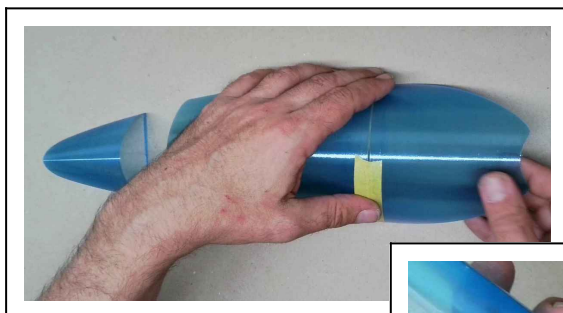

3. Now place the canopy into the frame and fix it with masking tape along the joint. Apply a line of glue from the inside along the joint, allow to evaporate, cure and remove tape again.



4. Glue a 10mm piece of filament or a \varnothing 1,8mm \times 10mm steel wire (nail) into the hole of the frame as positioning pin and then the hook from inside to the top. Attach a rubber ring to the gear frame, hook the other side to the canopy hook, then guide the pin into the hole in the fuselage and snap on canopy.

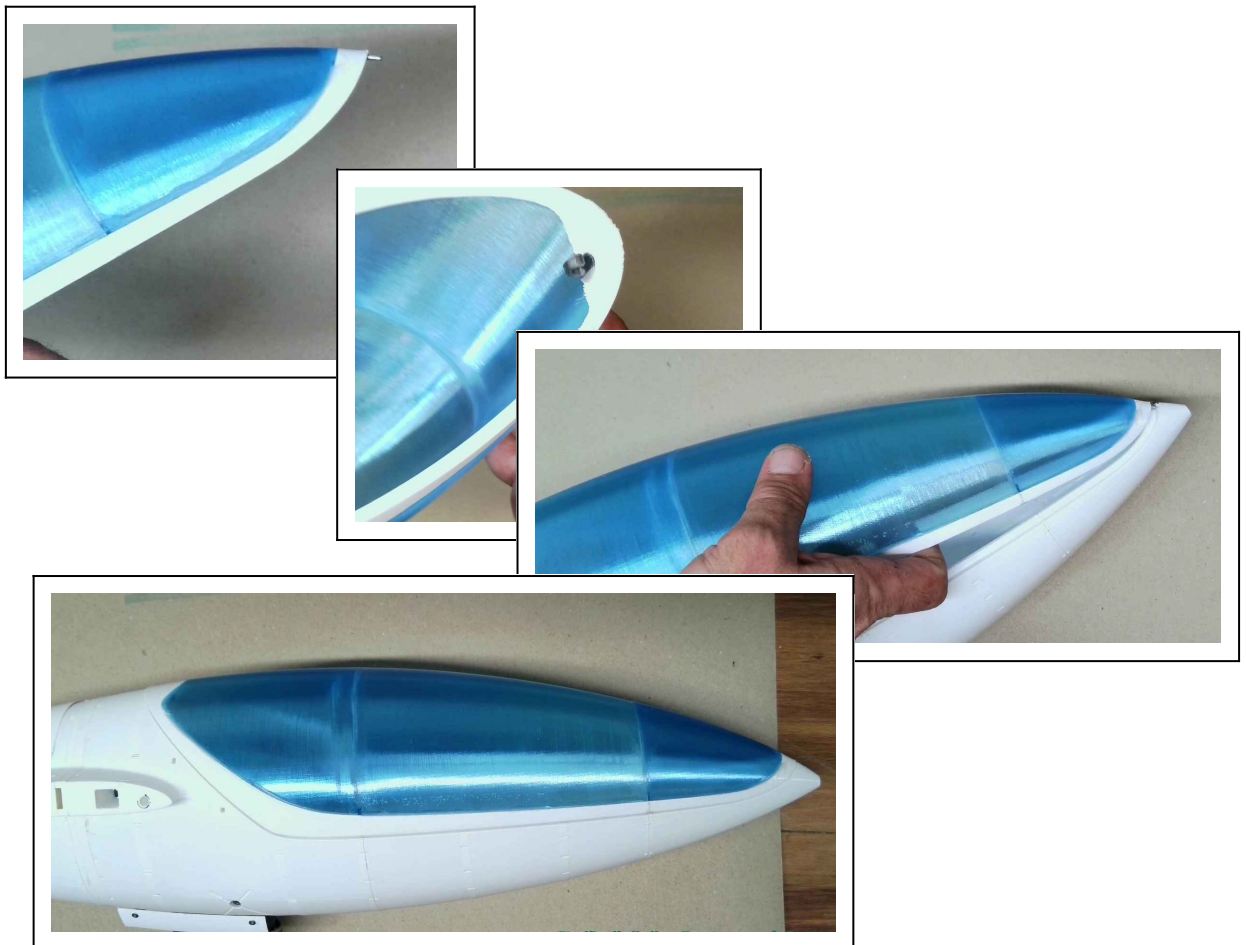

Excursion: Thermoforming the canopy glass

Thermoforming parts is fun and easy and you can generate the equipment needed with few effort. You will need:

- resin print of the canopy mould
- kitchen oven with a reasonable temperature control
- wooden frame in the size of your baking tray
- vacuum cleaner
- vacuum boxf
- window sealing tape
- leather gloves

Creating the box and frame:

Measure the size of your baking tray and get some 10mm x 30mm wood strips to build a matching frame. You can use any joint of your choice, like lashing, only one side has to stay flat.

Now use some boards (old coated shelf boards work well) and wood-screws to build a box slightly larger as the frame and deep enough to apply a hole in the size of your vacuum cleaner hose-tip to the side. It doesn't have to look pretty but needs to be passably airtight.

Now drill a grid of 3-4mm holes into the top of the box and apply window sealant tape matching the frame you made on top.

Preparation:

Smoothen the resin print very carefully, wet sanding is recommended here. The better the surface of the mould, the better results you will gain.

Remove protective film from the Plexi sheet and use a stapler or small nails to fix sheet to the flat side of the frame.

Bring your vacuum box next to your oven, set the mould on top and fix with double-sided tape then plug the vacuum cleaner to the side.

Finally have your gloves ready and you are good to go!

[Watch this video how its done.f](#)

Thermoforming:

Heat the oven to 120° - 160°C depending on the manufacturers specs, put the frame with the sheet-side up into the oven, get on your gloves and have your vacuum ready. Carefully watch as the sheet warms up and begins to sag until it reaches about 5cm, then turn on the vacuum, open the oven and get and turn the frame. Without much hesitation position it over the box and press it onto the sealing.

Now watch and enjoy your canopy coming into form. You can use a hair dryer to help it getting into the corners. In case you have crinkles, just remove, reheat and retry.

Finally lift from the form, remove frame and use scissors and sanding paper to bring it into shape. I recommend using clear silicone to attach the frame here.

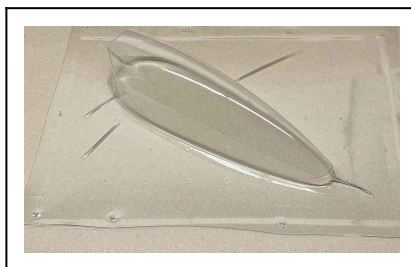

- Not in the mood for thermoforming? Get your pre cut canopy glass [here!](#)

Part 6: Final assembly and RC installation

3D-prints:

- DG-600_receiver-carrier
- DG-600_battery-mount_left and _right
- DG-600_ESC-carrier-frame

RC- and standard parts:

- RC- transmitter
- RC- receiver
- ESC
- 4x servo extension cord ca. 20cm
- Li-Po battery
- 10mm Velcro strip
- some cable ties and self-adhesive sockets

Screws:

- 4x M2 x 20mm, countersunk



1. Use cable ties to attach receiver and way-extender to the carrier then apply double sided tape to the bottom, plug the extension cords to the aileron- and flap servo channels and stick unit to the fuselage, right in front of the gear mechanics.

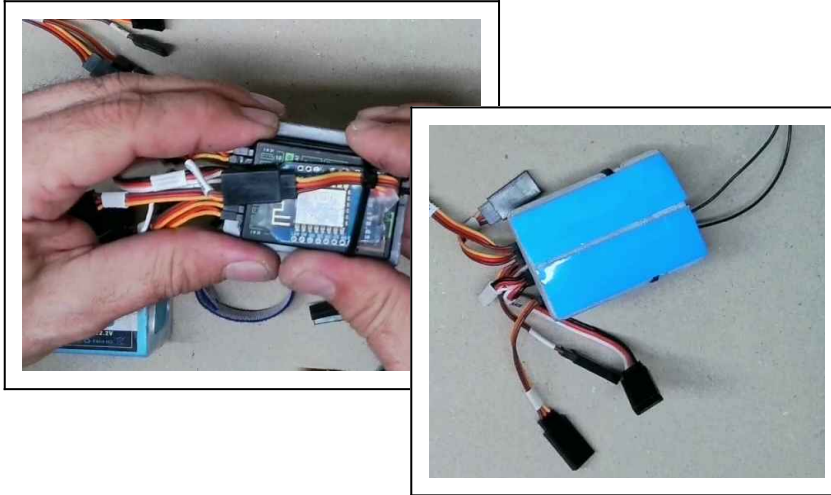

2. Guide the flap and aileron extensions from receiver to the cable openings left and right in the fuselage, arrange and plug in the remaining servo cables to your receiver accordingly and use cable ties and sockets to prepare a clean sweep, but don't tighten the ties completely yet.

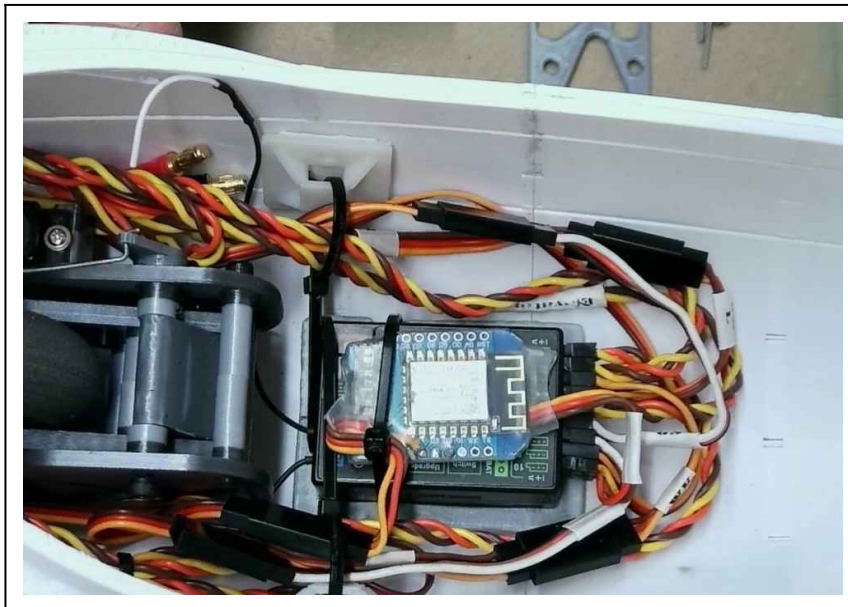

3. Fix ESC on the carrier-frame with zip-ties, then install with M2 x 20mm screws and connect motor and receiver with the ESC.

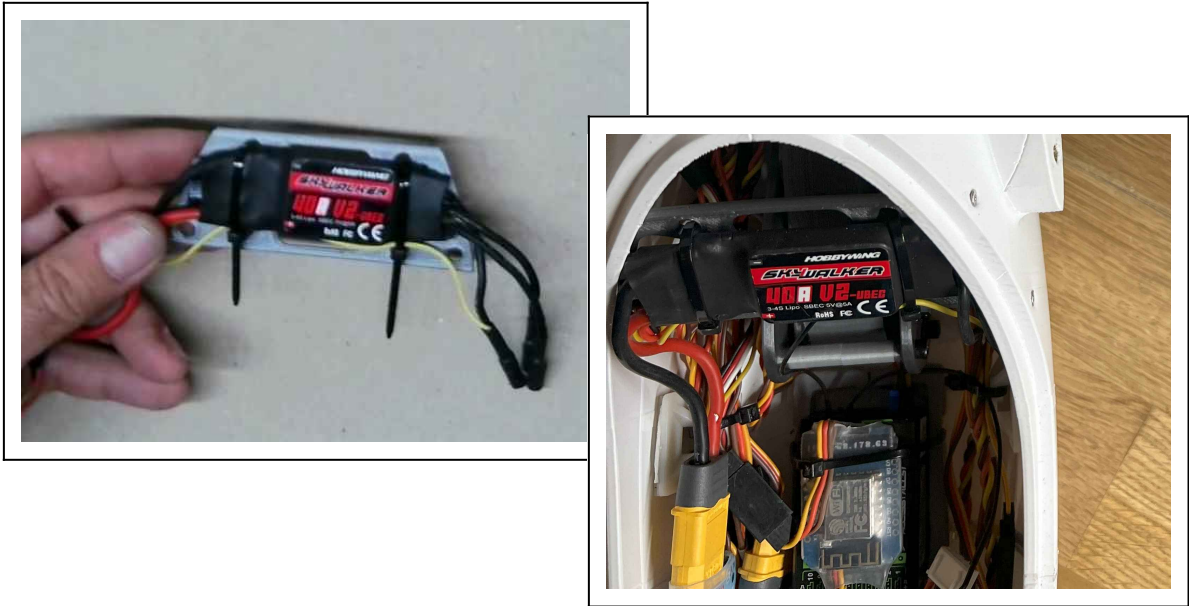

4. Now its time to attach the wings. Take out the M6 centre screw and check at end of its thread for sharp corners and smoothen. (This part will have direct contact to the wing-connector and we really don't want to work that through;) . Turn in the M6 screw enough to allow passing and insert first only the tip of the wing connector, plug in the servo cables, then guide them inside the fuselage while sliding on the wing completely. Repeat with the other side, check wings and the four bolts for settlement, then lock by carefully tightening the M6 screw (an Allen key with ball-head is helpful here).

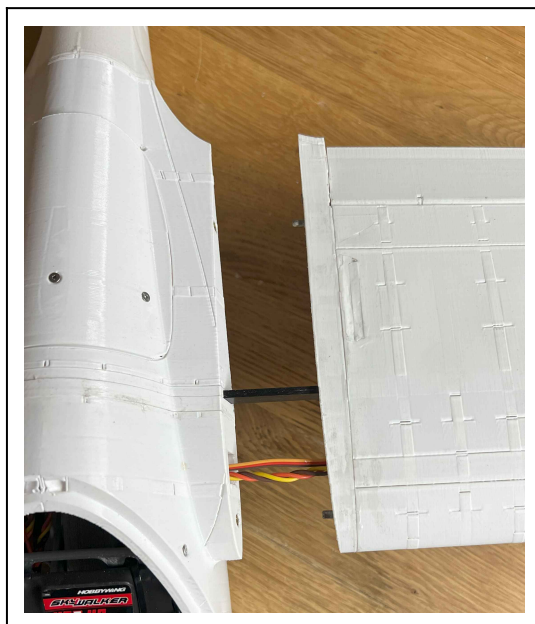

5. Loop your battery with the Velcro and the mount-blocks attached to, then place inside the fuselage. Support the aircraft in the centre of gravity (43mm-45mm from leading edge) and move the battery until its balanced, then mark position. (Keep in mind to apply the canopy before balancing! Or much better: apply some temporary weight to compensate.)
Hold the battery in place and slide Velcro to find a suitable position for the mount-blocks, then lift, apply glue to blocks and put back in, while still attached to the battery. Apply some pressure to the blocks and cure.

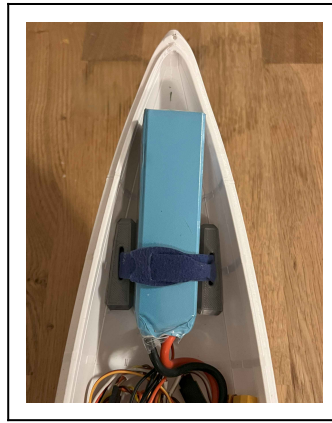
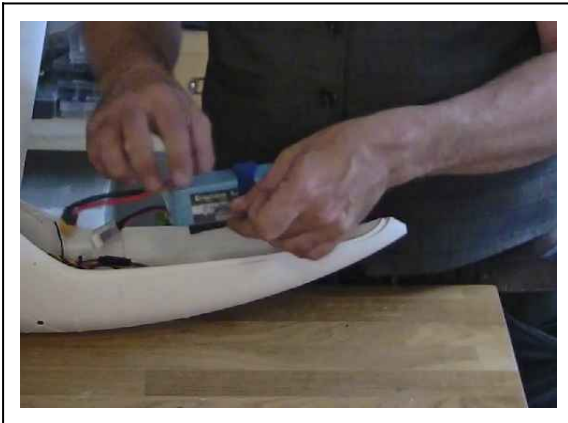

6. Now tidy up the wiring to the final, giving good care to the wheel / EDF area and close the remaining zip ties.
Attention! The MG90 servos, I favour are sturdy, reliable, reasonable priced and even able to go 180°, if provided the right input,
...**BUT** they are known to burn quickly if seriously driven against block.
So have your ears on the servos at first power up and set endpoints for gear and EDF servos first!



Part 7: RC- setup

Once my mentor taught me: "A good model pictures the originals primary properties...", which in case of the DG-600 is clearly High-Performance, "... and will point out its problems." and that is the small tolerance band here.

Simply spoken: Our sweet spot is sweeter, but smaller.

We faced already the small band -just 2mm- for the centre of gravity, when balancing. Already small changes in CoG or the alignment of the elevator to the strak will have noticeable results. So pay special attention to the adjustment of the elevator and balancing.

To gain full functionality we need a programmable RC system, with 9 channels or more, but fortunately nowadays the majority is and even a ten year old Taranis will be perfect for the job.

And there is very good news for all OpentTX, EgdeTX or EthOS users:

rc-soar.com offers very useful free setup-templates for [OpenTX](#) and [EthOS](#).

Do the setup with the following values:

Centre of gravity 43mm-45mm			
Control movements:		Expo:	
Elevator	7mm / 7mm	30%	
Rudder	max.	20%	
Aileron -norm/therm	12mm / 7mm	25%	
Aileron -speed	15mm /12mm	30%	
Flight modes:	Aileron:	Flap:	Elevator:
Speed:	2mm up	2mm up	-
Normal:	-	-	-
Thermal:	2mm dn	3mm dn	-
Crow:	6mm up	30mm dn	3mm dn

EDF: Additional set your ESC to soft-start and programme a logic switch to drive **out** the EDF unit in case the engine is activated and **in** with some coasting delay, when throttled. In connection with an engine disarming switch this can be used to drive out the EDF for maintenance purpose.

Gear: Depending on the foaming factor of the tire-material used and the length of the EDF linkage, it might happen that the servo horn obstructs the way of the wheel, when the EDF unit is retracted. Instead of grinding down the tire or fiddling with the linkage, it's the easiest way to set up another logic switch, that will lift the EDF a little on gear movement with retracted fan. So have yourself a polite aircraft, that will lift hat, when stepping in and out. Chapeaux!

Part 8: The first flight

Start:

Though it its possible to hand launch the DG-600, it is a faster flying plane and you will need a trained person to throw or some reasonable headwind, or preferably both to succeed in. So I recommend doing the first take-offs from the runway.

After a final check of the control-surfaces and the CoG, set the plane onto the runway, the nose pointing into the wind and (ask a mate for) support to level the wings.

Now fully pull elevator to prevent from dipping the nose and throttle up, hold direction with the rudder and use greater aileron commands to balance the wings in the beginning, release elevator when gaining speed. Now allow to speed up and as soon as the tail lifts, you can carefully apply elevator to lift off.

The difference to motor gliders with propeller, you might know is, an EDF needs some airspeed to deliver best thrust. So keep pace, maybe enjoy some banked turns and get to a comfortable height. Stop engine and retract the gear (if not in already), then do the trims for the different flight modes and the landing (crow/butterfly) position.

Landing:

As with all soaring planes, a good planing of the landing arrangement is important, but here you can assist with the engine to reach the final approach. Now cut throttle, mind to have your gear put down and use crows to loose height, but keep at pace until near ground. Then fully apply crows and carefully flare out, adding more elevator until the wheels touch ground. The goal is to have the tail wheel touching the ground just before the main wheel will, to get the perfect landing.

No worries, landing on short grass with the gear out! Including the doors it's very sturdy and also easy to replace.

Now go chasing clouds, enjoy flying and have many happy landings with your DG-600-Jetpower!

Links:

[IFA YouTube channel](#) -Here you'll find videos, guides and more!

[IFA Supply Store](#) – Data – Special Parts – Accessories

[IFA twitch channel](#) – Builds – uncut and live, join in and participate!